

User's Manual

VF3000A

ATI Radeon HD 5830

ATI Radeon HD 5850

ATI Radeon HD 5870

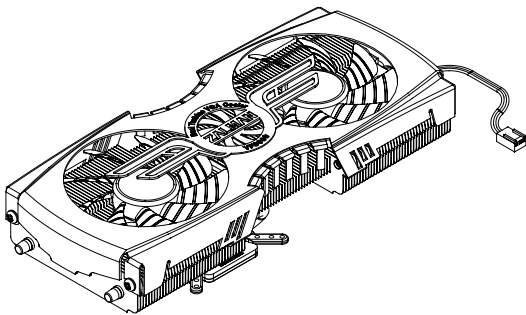

To ensure safe and easy installation,
please read the following precautions.

<http://www.zalman.com>

1. Precautions

- 1) This cooler is specifically optimized and designed for reference VGA cards ATI Radeon HD5830, HD5850 and HD5870.
- 2) By installing this product on a VGA (Video Graphics Array) card, two PCI slots immediately below the PCIe (or AGP) slot occupied by the VF3000A will become unusable.
- 3) If this product is to be installed on a recently released VGA card, please check for compatibility at Zalman's website first.
- 4) If the VGA card and/or its components interfere with the installation of this product, then stop the installation, refer to the list of compatible VGA cards or motherboards at Zalman's website, and install this product with one of the compatible VGA cards or motherboards.
- 5) Do not ingest the Thermal Grease, and avoid its contact with skin and eyes. If contact is made with skin, wash off with water. If ingested or any irritation persists, seek medical attention.
- 6) To prevent possible injuries, gloves must be worn while handling this product.
- 7) Excessive force exerted on the fan may cause damage to the fan and/or system.
- 8) Please keep out of reach of children.
- 9) Check the components list and condition of the product before installation. If any problem is found, contact the retailer to obtain a replacement.
- 10) During transportation of the system, the cooler must be removed. Zalman is not responsible for any damages that occur during the transport of a system.
- 11) Product design and specifications may be revised to improve quality and performance.

Disclaimer) Zalman Tech Co., Ltd. is not responsible for any damages due to external causes, including but not limited to, improper use, problems with electrical power, accident, neglect, alteration, repair, improper installation, or improper testing.

2. Specifications

Spec.		Model	VF3000 A
Material	Fin		Pure Aluminum
	Base		Pure Copper
	Heatpipe		Pure Copper
Weight			430g
Dimensions			239(L) × 98(W) × 51(H)mm
Fan	Bearing		EBR Bearing
	Dimensions		92(L) × 92(W) × 15(H)mm
	RPM [Fan Mate 2]		1300 ~ 2500 rpm ± 10%
	Noise [Fan Mate 2]		18 ~ 32 dBA ± 10%

3. Components

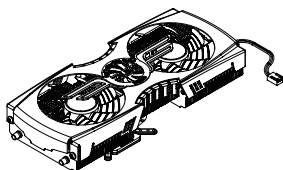

VF3000 A

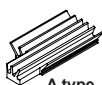

A type

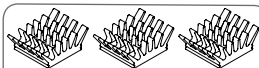

B type

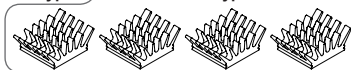

VGA RAM Heatsink
(A type × 1, B type × 7)

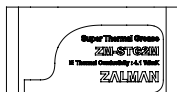

Thermal Grease
[ZM-STG2M]



User's Manual



Rubber Rings × 4

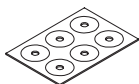

PVC Washers × 6



Fixing Nuts × 4



Springs × 4

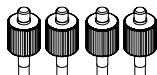

Nipples × 4

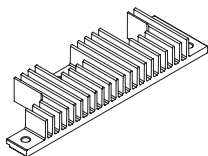

FET Heatsink

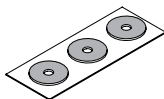

Rubber Washers × 3

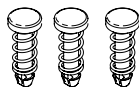

Fixing Pins × 3

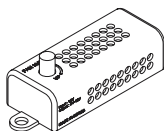

Fan Mate 2

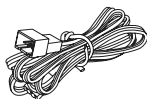

Fan Mate 2 Cable

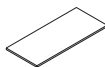

Double-sided Tape

4. Exploded View

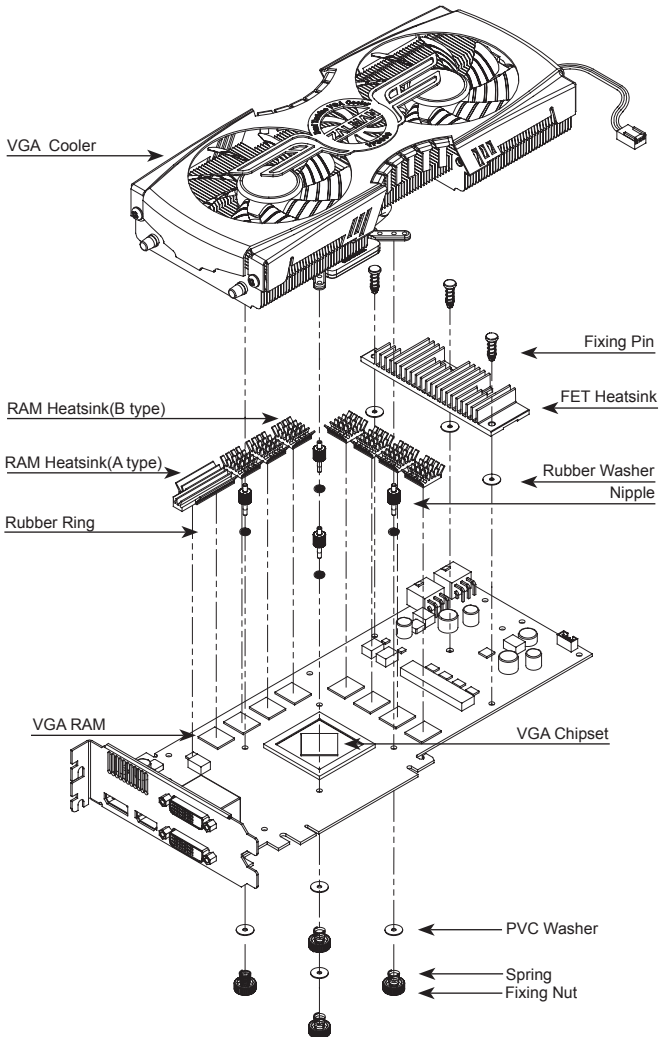

5. Installation

1) VGA RAM Heatsink Attachment

Remove the film from the Thermal Tapes on the bottom of the RAM Heatsinks and attach the Heatsinks to the VGA RAM.

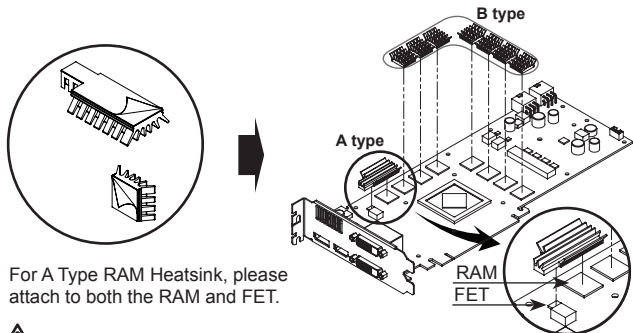

For A Type RAM Heatsink, please attach to both the RAM and FET.

⚠ Caution

- ▶ Clean the surface of the RAM with acetone or alcohol before attaching the RAM Heatsinks.
- ▶ The bonding strength of the Thermal Tapes reaches 90% after 24 hours of curing. Do not exert excessive force on the RAM Heatsinks during this period.
- ▶ Thermal Tapes are not reusable because they lose adhesiveness after their initial application. Purchase new Thermal Tapes if the RAM Heatsinks need to be reattached.

2) FET Heatsink Installation

- ① Remove the Double-sided Tape covers from the Rubber Washer and attach to FET Heatsink.

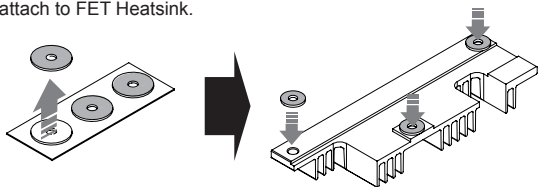

- ② Apply Thermal Grease to the FET chipset while leaving enough Thermal Grease for VGA chipset application.

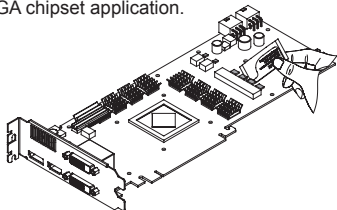

- ③ Please remove the sticker's lamination from the FET Heatsink's Rubber Washers and install to the VGA card using the Fixing Pins.

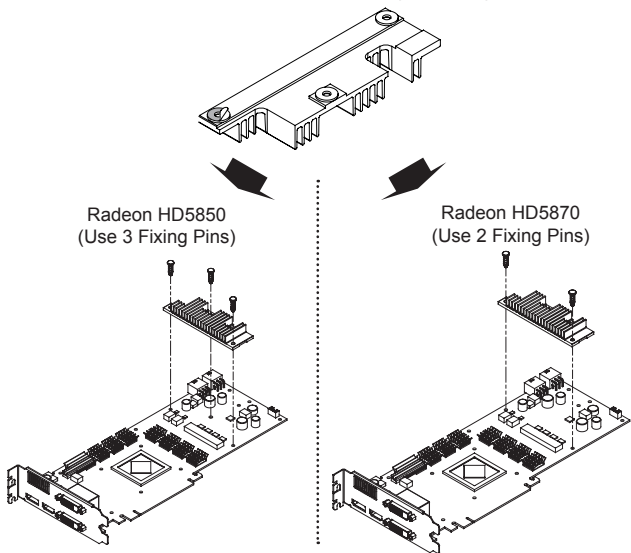

Caution

- ▶ Since the FET Heatsinks are optimized and designed for the HD5870 and HD5850 reference cards, please check the card before installation.

3) Thermal Grease Application

Clean the contact surface of the VGA Chipset completely. Apply a thin and thorough layer of Thermal Grease on the contact surface of the VGA Chipset that touches the base of the VGA cooler.

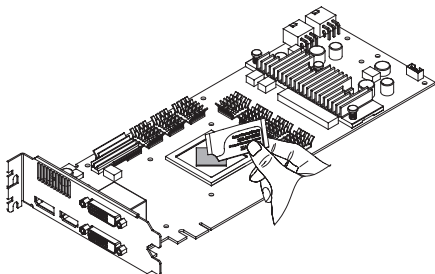

4) Nipple/Rubber Ring Installation

Fasten the Nipples and Rubber Rings to the VGA Cooler's Fixing Guide.

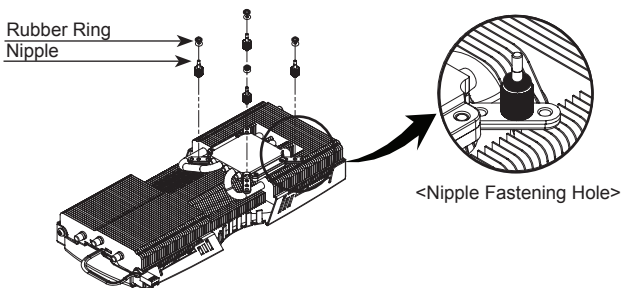

5) Cooler Installation

After installing the Nipples and Rubber Rings to the Cooler, mount the Cooler to the VGA Card.

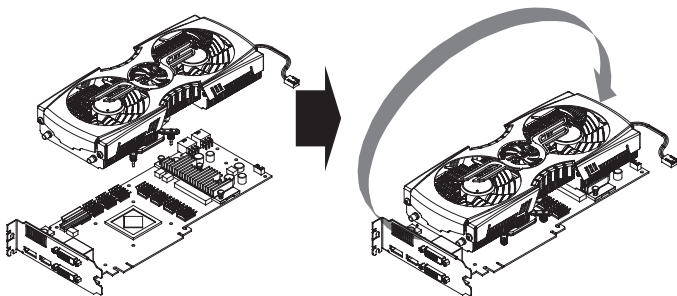

6) Cooler Fastening

With the Cooler's bottom facing up, completely fasten the PVC Washers, Springs and Nuts to secure the Cooler.

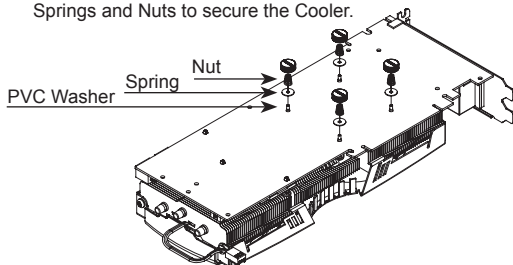

⚠ Caution

- ▶ Please tighten each of the 4 Fixing Nuts one rotation at a time until all are completely tightened.
- ※ Completely fastening one Nut at a time can cause damage to the VGA Chipset.
- ▶ Make sure the Cooler Base is installed in full adhesion with the VGA Chipset.
- ▶ Make sure there is no physical interference between the VGA card components and the VGA Cooler.

7) VGA Cooler Installation

Install the VGA card to the slot after mounting the cooler.

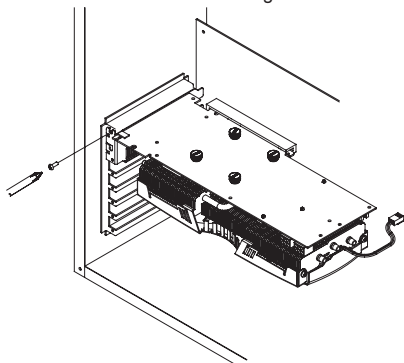

6. Fan Mate 2 Installation and Usage

1) Fan Mate 2 Installation

- ① Connect both the motherboard and the Fan Connector to the Fan Mate 2 as show in the diagram below.

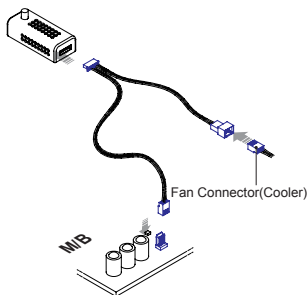

- ② Fan Mate 2 can be installed to the side of the case using a Double-Sided Tape.

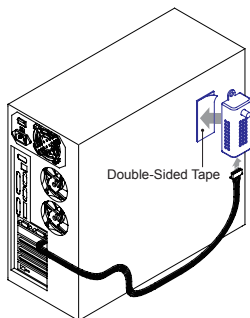

2) Fan Mate 2 Operation

Adjust the desired RPM setting by moving the Fan Speed Control Knob left or right.

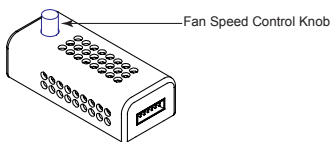

ATI HD5830 User's Manual

- ▶ This manual is for reference VGA card HD5830 users.
- ▶ When installing the VF3000A on the HD5830, the FET Heatsinks are not used.
- ▶ The installation location of the Ram Heatsink (A) differs from the locations of the HD5870 and HD5850.
- ▶ Please refer to the manual for detailed installation instructions.

