



**Flexible motion solutions for your
high-speed applications**

PACMotion™ Servo Solutions
Improve your machine's performance and efficiency
with a high-speed, integrated motion control system.



You're expected to meet your customer's demands with speed, agility and quality.

Whether you're in the business of creating machines or using them in your operations, you are being asked to design and develop high quality solutions with reduced personnel amid increased pressure to bring your product to market faster and at a lower cost. You need a trusted, experienced partner who can help you deliver high-quality on your commitments with end-to-end solutions.

"Only 55% of all product launches take place on schedule."
-Gartner



"Prices may vary, but the project risks severely outweigh the product price."
-Motion industry analyst



"In motion control, users and OEMs want a package that can be bought and used as a system. Because the in-house information base is frequently limited, they need application knowledge in their suppliers."
-Motion industry end user



"Manufacturers are always looking for ways to reduce costs, become more efficient, and increase output. IIoT-enabled motion controllers allow for enhanced communications through connected manufacturing, with data-driven decisions facilitating faster improvements."
-Motion Control & Motor Association



What if you could find a high-precision motion control platform that tightly integrates motion and machine logic in a single software environment for quick start-ups, fast changeovers and increased throughput?

PACMotion takes motion control performance to a new level with superior speed, integration simplicity and ease of use.



You know that integrating multiple systems is time consuming and challenging. PACMotion™ solutions, along with PACSystems™ PLCs, create a powerful, integrated control and motion servo solutions platform that enables you to easily design, develop and maintain your machines.

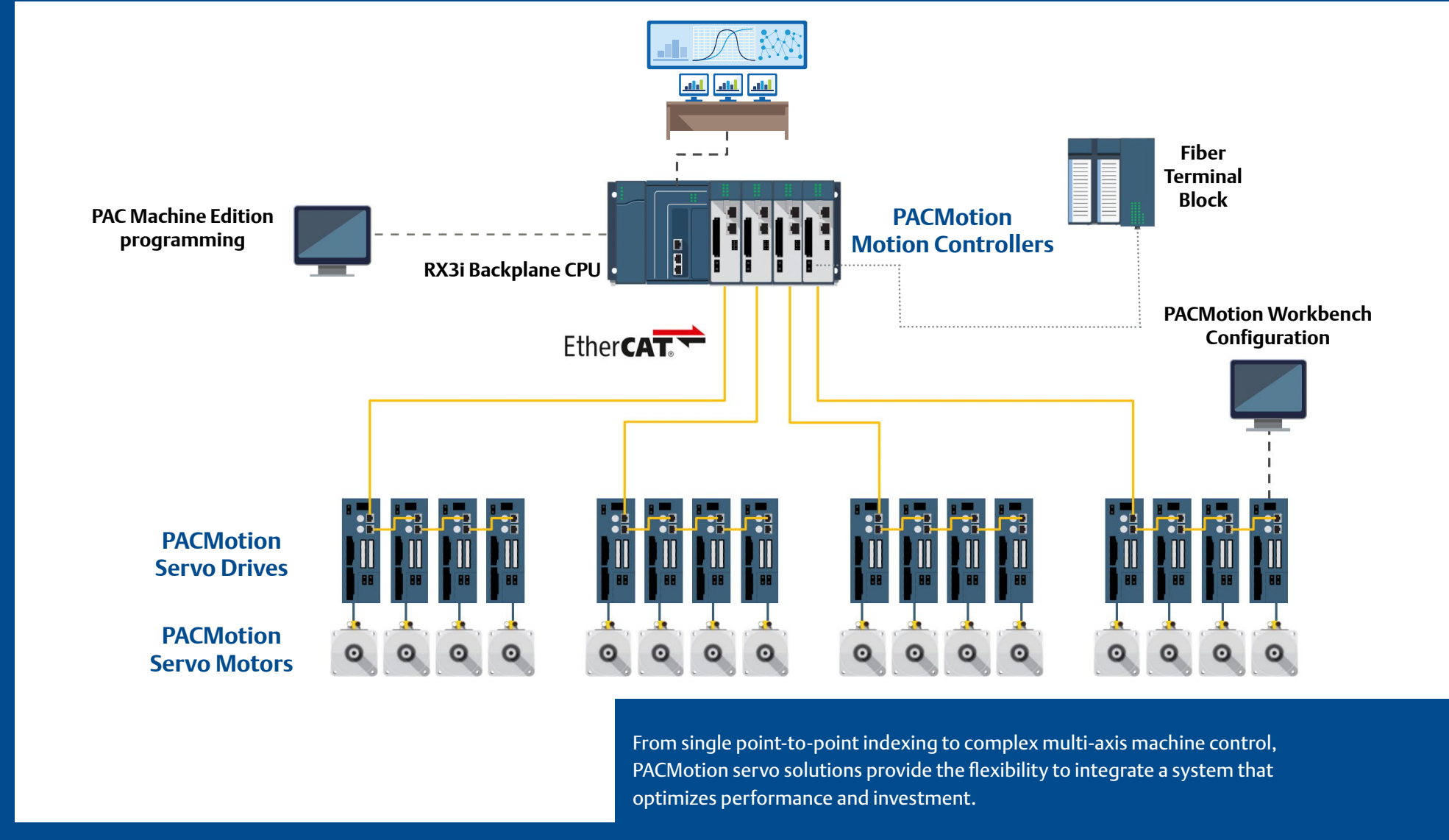

From single point-to-point indexing to complex multi-axis machine control, PACMotion servo solutions provide the flexibility to integrate a system that optimizes performance and investment.

Seamless integration speeds development and reduces costs.

Whether you're implementing a new system or modernizing your legacy controllers, PACMotion simplifies and speeds development with one integrated programming environment for PLC logic, motion control, HMI and safety. Common programming across applications helps speed commissioning and simplify upgrades.

High performance motion control increases speed, precision and yield.

The unique design of the PACMotion controller allows higher speeds than traditional networks, while 64-bit floating point precision and patented JerkFree technology enables users to program with microsecond accuracy.

Exceptional application versatility helps improve ROI.

PACMotion solutions save money up front and over time with fast commissioning, rapid changeovers, high reliability and built-in diagnostics to reduce downtime and lower total cost of ownership.

Reliable performance and unsurpassed productivity in the toughest environments.

Faster product turnover, greater variability and shorter production require flexible modular control systems that can keep pace with today's extreme production demands. PACMotion solutions are as durable as they are versatile and scalable, improving application performance and boosting productivity.

Improve and simplify your motion capabilities with a completely integrated system.

PACMotion combines an integrated motion and machine logic solution with the performance, flexibility and scalability required for advanced machine automation. Configured to provide easy integration and development, greater precision and yield, and reduced maintenance, the PACMotion system of controller, drives and motors are designed to work together in applications from just a few to up to 40 axes.

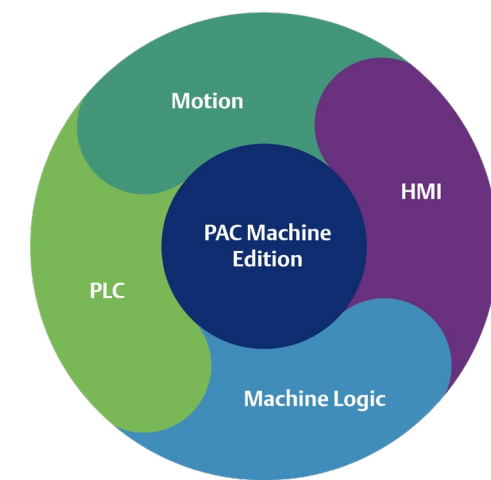
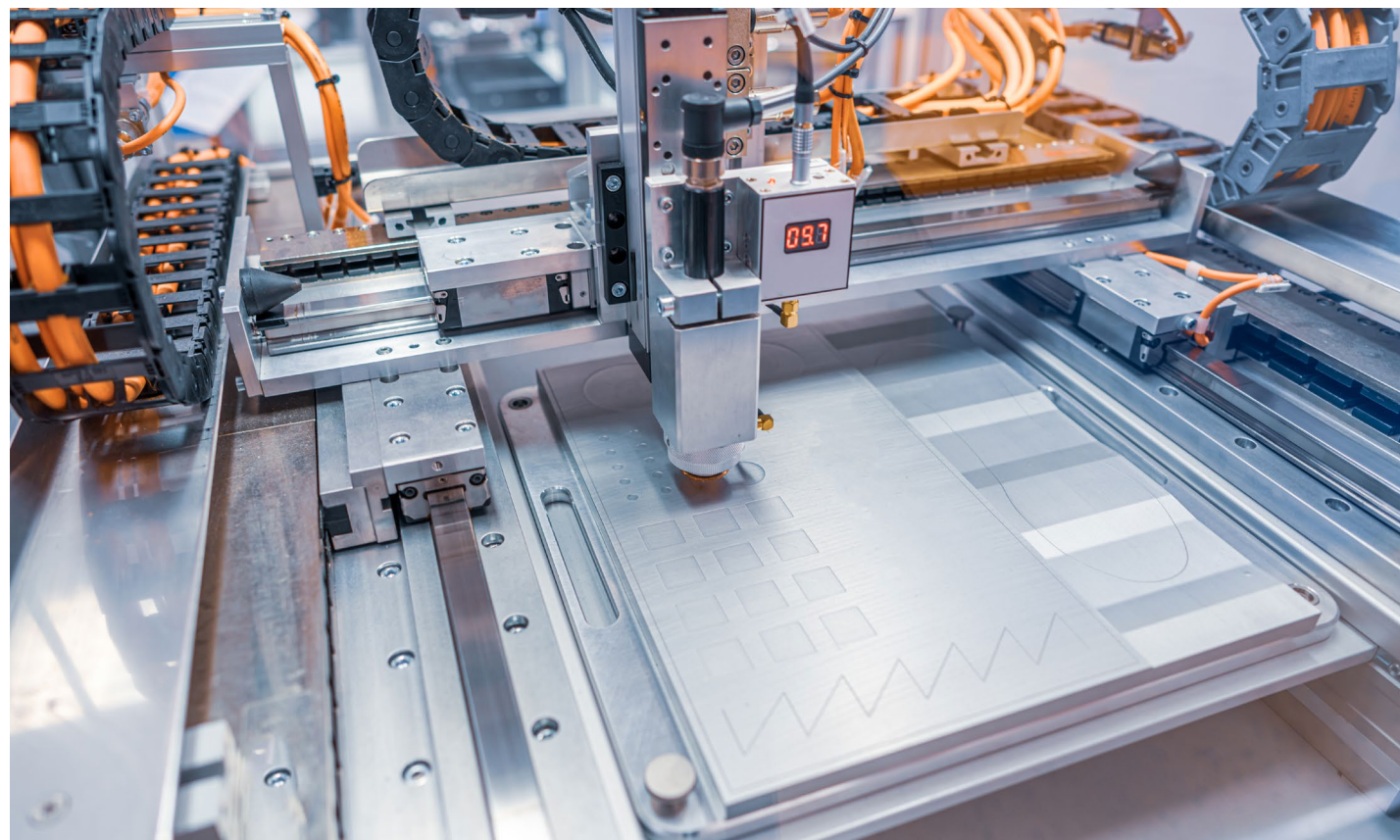

Simple integration with enterprise control systems

Because the PACMotion controller is implemented through the powerful PACSystems runtime, users and OEMs receive easy access to enterprise-level supervisory control systems and SCADA, including edge and IIoT solutions.

Higher throughput

High-performance motion controller



- EtherCAT communications updated every 250 μ s
- Position loop updated every 500 μ s
- Path planner loop updated every 1 ms

The power of motion control directly connected to the PLC backplane



- 1 Gbps throughput backplane communications
- Event and motion-timed interrupts available to execute logic independent of the standard PLC scan

Higher yield

Higher accuracy



- Achieve motion programming and control with 64-bit floating point precision
- Motion profile between path planner updates with microsecond accuracy

Higher precision

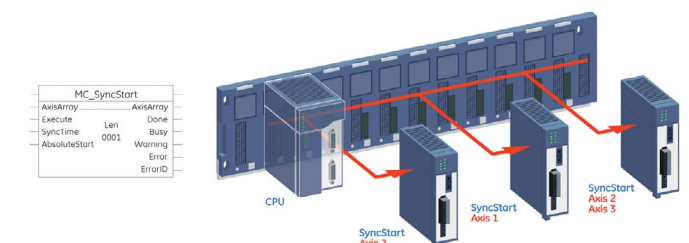

- Synchronize the start of motion of up to 40 axes
- Enjoy faster settling to final motion positions and avoid material slippage at any point in the motion execution

Reduced capital and operating costs

On-the-fly reconfiguration



- Change master axes, camming or gearing profiles on the fly
- Take advantage of shorter production runs and optimize machine utilization with rapid line changeovers

Powerful diagnostics

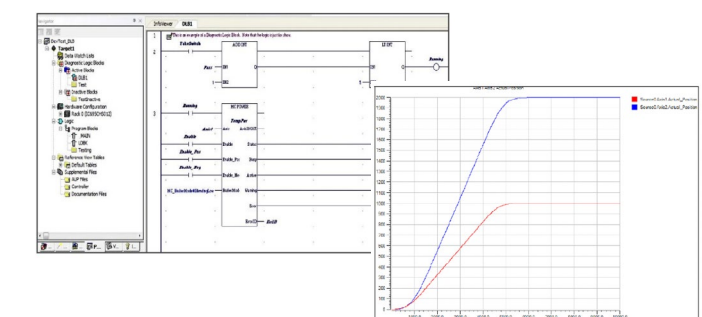

- Access motion programming directly from the PLC
- Powerful PAC Machine Edition data logger with graphical capability



Rapidly design, develop, maintain and scale motion control applications to your system requirements.

PACMotion offers optimal value because it enables up to real 40 servo axes and 10 virtual axes per PLC. Enhanced from previous generations, PACMotion offers a scalable solution, allowing additional axes of motion to be synchronized without changing the controller architecture. With PACMotion, many machine applications can be integrated into a single controller, reducing costs and increasing system flexibility. Machine setup, commission and upgrade are simplified. Users and OEMs can design a machine with a range of optional features without impacting baseline performance of the machine. Because of the embedded co-processor, PACMotion offers easy expansion on the fly with no redesign of architecture.

Versatile, scalable performance

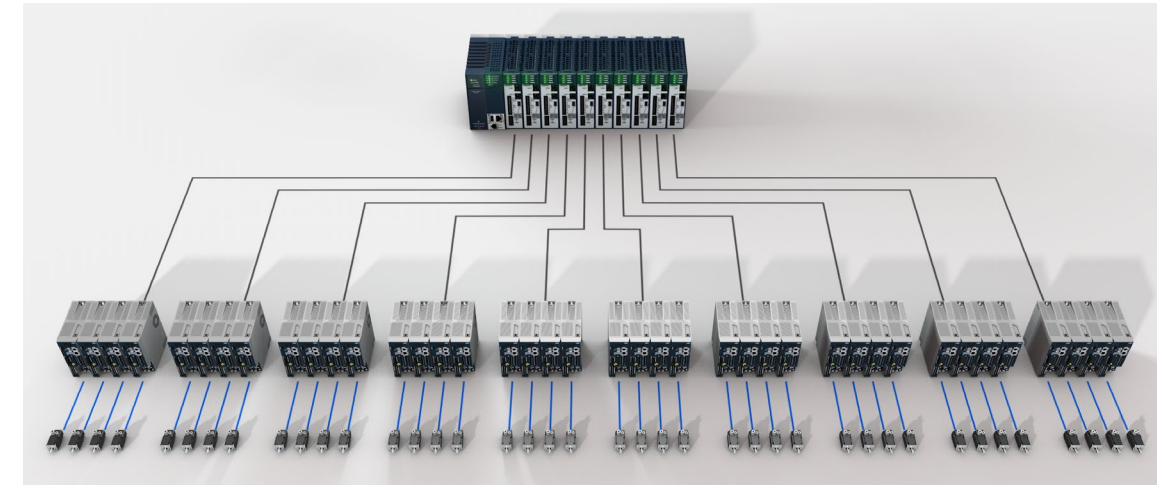

Seamless integration with PLC



- Single software tool to program both PLC and motion controls
- Motion module connects directly to the PLC backplane

High-performance motion processing

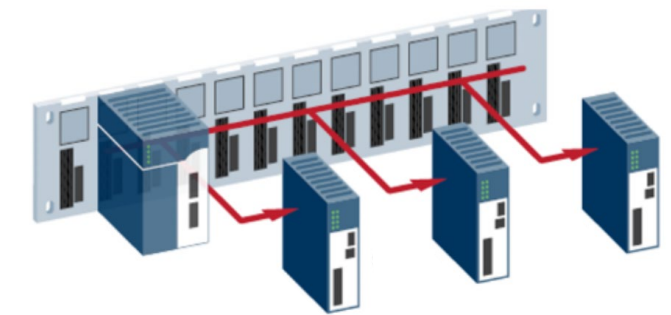

- PACMotion is based on PACore, a multi-core CPU architecture whereby the PAC CPU runs the application program while up to 10 dedicated co-CPU's run the motion algorithms

Up to 40 coordinated servo axes without performance degradation

- Each PMM345 accommodates up to four physical and one virtual axis
- Up to 40 synchronized axes on a single PLC backplane
- Simplifies machine setup, commission and upgrades in the field

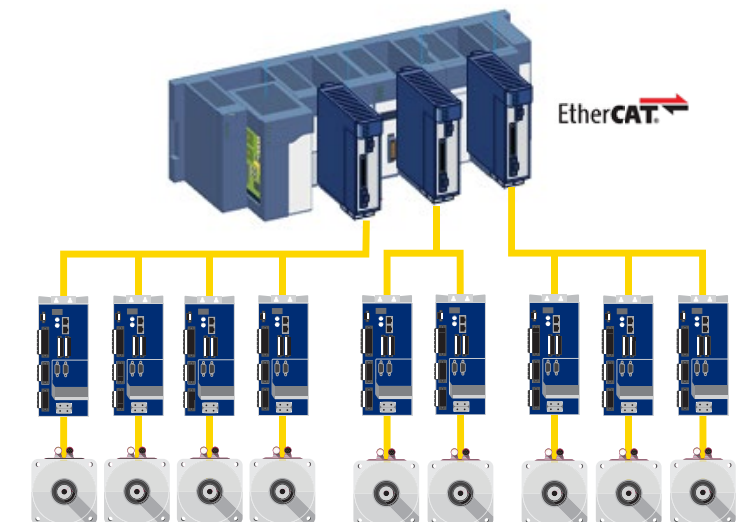



System migration without the hassle



Components that remain the same:

- Operator interface and HMI
- PACSystems RX3i controller, backplane, local I/O hardware and standard control program
- PACMotion PLC open program
- Motion I/O
- Identical motor mounting dimensions

Swap in new, easily integrated motion components



- EtherCAT-based motion controller card, the PMM345 in place of existing PMM335
- PACMotion Servo amplifiers and communications cable
- PACMotion Servo motors (with matching flange, bolt pattern, and shaft)
- New combined power and control cable between PACMotion Servo amplifiers and Servo motors

Reduce time and cost when you migrate from legacy systems.

Users hesitate to migrate to current motion technology because the process is time-consuming and costly. PACMotion enables fast, easy upgrades from your legacy systems for an enhanced, completely integrated motion solution to meet the productivity and throughput demands of today's high-speed machines and lean manufacturing environments.

What's your challenge?



"In motion control, retrofitting is more common than greenfield and users need seamless integration with existing architecture."
–Motion industry expert

What's your opportunity?



Previous users of PACMotion systems can maintain most of their current design while upgrading to advanced technology.

PACMotion PMM345 Motion Controller: An evolution and revolution in motion control

The PACMotion PMM345 controller advances far beyond standard motion control. The ease of integration, enhanced performance and simple path for migration all translate to significant savings in time and money, as well as substantial improvements in precision and flexibility. The PACMotion controller provides both experienced and new users an easy pathway to motion control, while advancing to a new generation in performance and productivity.



A powerful solution for complex motion control

Unlike most PLC-based motion, PACMotion delivers consistent motion update rates regardless of the number of axes. Fast motion path planning and rapid position update rates deliver improved accuracy and faster response to changing control requirements. Precise positioning and synchronization help reduce product scrap and improve production yield.

Flexible data exchange



- Receive updated data faster to make better decisions faster without the need to wait for end of PLC scan
- Reduce scan impacts for faster program execution
- Gain real-time access to the most recent motion data

Real-time motion synchronization

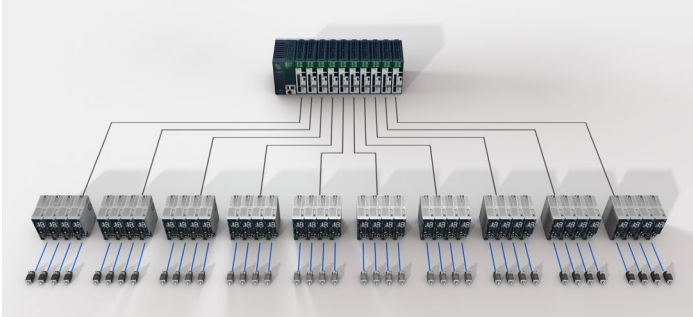

- Simultaneous position loop control helps ensure precise positioning of all axes in the rack while eliminating phase errors
- Synchronize the start of motion on up to 8 axes

Dynamic motion control

- Powerful cam functionality provides tighter synchronization of axes, allowing simultaneous updating and on-demand data exchange with no performance degradation
- Without an interruption in your production, all masters and secondary axes can be determined in real time as well as engaged and disengaged—enabling dynamic axes synchronization management to increase machine uptime

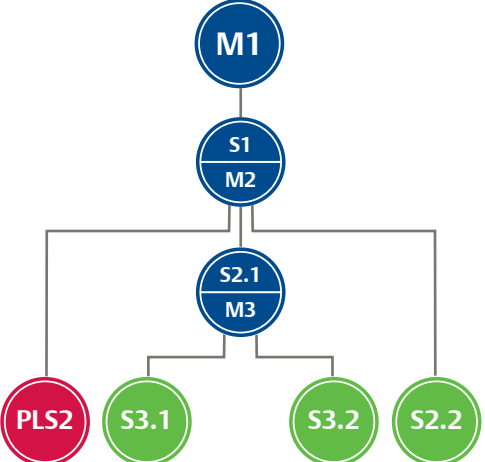

Synchronize machine logic and motion



- 3 interrupts available to seamlessly trigger time or event critical logic
- Timed: 2 ms to 40 ms in 0.5 ms increments; synchronized with axis position update
- Event: any of the faceplate or FTB inputs can be used to trigger interrupt block

PAC Machine Edition

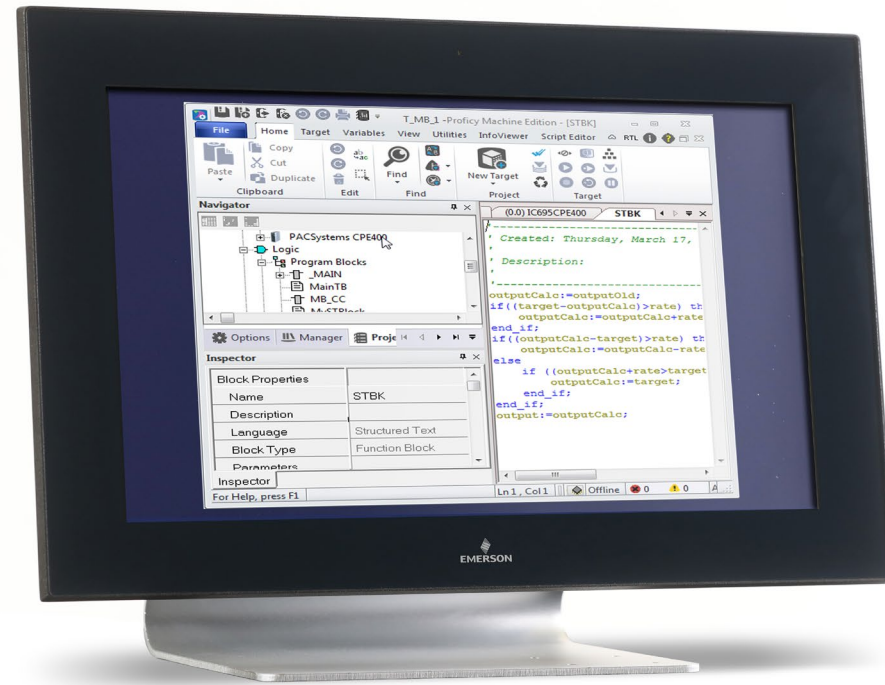

Reduce development costs and speed time to market with the aid of a single, powerful programming tool. PAC Machine Edition (PME) lets you program and implement all aspects of control architecture – PLC logic, motion control, HMI and machine safety – all from the same programming environment. The open programming standards and protocols of the PACMotion software platform further speeds development and enhances interoperability. A graphical user interface enhances ease of use. With PME, you can meet application demands quickly and seamlessly.



Integrated motion control in a powerful, versatile package

The PACMotion multi-axis motion controller is designed to deliver unsurpassed machine productivity, ease of integration and programming, shorter development cycles, and higher reliability.

- Seamless integration of control functions reduces engineering time and lowers total cost of ownership
- Real-time access to motion data reduces scan time and enables faster machine cycle rates
- Fiber-optic interface to motion I/O and drives delivers superior noise immunity, especially in distributed systems
- Fast, consistent motion update rates reduce machine cycle times and improve response to dynamic motion changes

Intuitive and integrated programming

- Utilize a single programming tool to deploy PLC logic, motion control, operator interface/HMI, and machine safety all from PAC Machine Edition programmer
- Common tag database for motion, logic and OI
- Simplify synchronization of motion and machine logic events
- Improve axis synchronization across multiple motion modules
- Access a powerful feature set that supports a broad application space
- Execute motion function blocks in real time

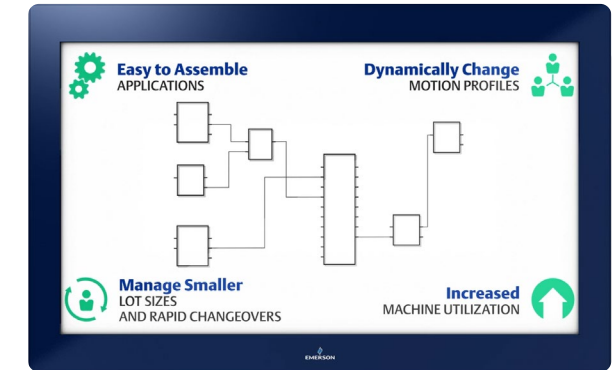

Open programming standards and protocols



- Native support for IEC-61131 programming languages including LD, ST, FBD
- Native support for C programming
- Support for a wide array of open protocols like EtherCAT, PROFINET, OPC-UA, and Modbus



- Native support of EtherCAT master on PMM345
- Suitable for high performance motion applications

Powerful diagnostics

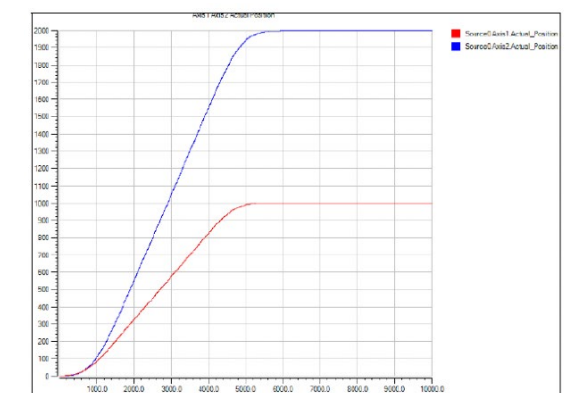
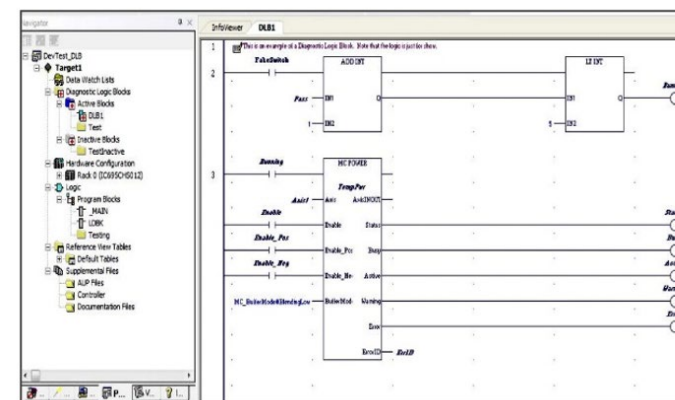

- Debug motion applications right from the PLC quickly and conveniently using integrated diagnostic logic blocks
- Validate machine operation by charting velocity, position and more with the integrated PME data logger

Servo Drives and Motors



PACMotion™ servo drives and motors deliver fast acceleration and superior accuracy to address the requirements of the most demanding industrial applications. Plug-and-play motor recognition and flexible integration features help speed startup and commissioning while the compact footprint allows easy integration into tight machine configurations. PacMotion servo drives connect to Emerson’s high-performance Rx3i EtherCAT motion controllers, adding networking and scalability to a feature-rich set of general motion application capabilities. Industry standard programming through PAC Machine Edition gives you the freedom to use the best language for your application. A common user interface, drag-and-drop editing, and a rich set of development tools enable easy programming, optimize resources, and improve application development efficiency.

Servo Drives/Amplifiers



Accelerate setup and optimize performance with plug-and-play compatibility with Emerson motors. PACMotion drives and amplifiers include flexible features for demanding applications.

- Optical I/O isolation with low-profile screw terminal connections
- High bandwidth and velocity loops provide exceptional machine control
- Real-time performance feedback delivers superior accuracy and resolution
- Broad feedback device support for added reliability

Servo Motors



PACMotion brushless servo motors deliver rugged versatility across a wide range of demanding applications with precision and accuracy. High acceleration rates provide superior machine cycle rates while the brushless design helps ensure efficient, low maintenance operation.

- Fast acceleration and superior power density deliver best-in-class performance
- Low harmonic distortion and low cogging torque design help ensure smooth, efficient operation
- Plug-and-play motor recognition and full-frequency auto-tuning result in fast deployment and ease of use
- Rotational cable mounts offer flexible servo mounting configurations



Designed for today's demanding machine control applications

Faster product turnover, greater variability and shorter production runs are at the heart of machine automation trends in industries such as packaging, food and beverage, printing, material converting, semiconductor, manufacturing and material working. End users and OEMs alike need complete integrated control solutions to speed time to market and reduce development and deployment costs. Today's plants demand the PACMotion advantage – high performance multi-axis motion control tightly integrated with a process automation controller, operator interface and extensive communications options all tied by one powerful software environment.

What's your challenge?



"Prices may vary, but the project risks severely outweigh the product price."
–Motion industry expert

What's your opportunity?



PACMotion's tight integration and high speed increase reliability and productivity, helping reduce project risk.

Industry applications

Packaging



- High-speed labeling
- Cartoning
- Wrapping

Printing



- Offset
- Winders/unwinders
- Infeed rollers

Semiconductors

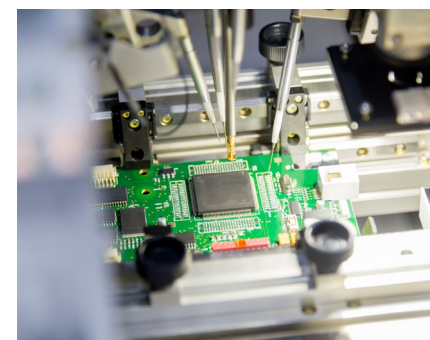

- Electronic assembly
- Washdown

Food and Beverage



- Form, fill and seal
- Filling and capping

Manufacturing



- Smart conveyors
- Transfer lines
- Adhesive dispensing

Material Converting



- Folder/gluer
- Rotary die cutting
- Laminating

Material Working



- Furniture/cabinet
- Truss making
- Metal forming

Drive productivity, reduce costs and optimize your return on investment.



**Emerson Automation Solutions
Intelligent Platforms, LLC**
2500 Austin Dr
Charlottesville, VA 22911
USA

**Emerson Automation Solutions
ICC Intelligent Platforms
GmbH**
Memminger Straße 14
Augsburg, Germany 86159

**Emerson Automation Solutions
Intelligent Platforms
(Shanghai) Co., Ltd**
No.1277, Xin Jin Qiao Road,
Pudong,
Shanghai, China, 201206

Emerson Automation Solutions
Rua Irmã Gabriela, 51 –
Cidade Monções
São Paulo – SP, 04571-130

**Emerson Automation Solutions
Intelligent Platforms Asia
Pacific Pte. Ltd.**
1 Pandan Crescent,
Singapore, 128461

**Emerson Automation Solutions
Intelligent Platforms Pvt. Ltd.,**
Building No.8, Ground Floor
Velankani Tech Park, No.43
Electronics City Phase I, Hosur Road
Bangalore-560100

 [Emerson.com/industrial-automation-controls](https://emerson.com/industrial-automation-controls)

 [LinkedIn.com/company/Emerson-Automation-Solutions](https://linkedin.com/company/Emerson-Automation-Solutions)

 [Twitter.com/MachineAutoSol](https://twitter.com/MachineAutoSol)

 YouTube.com/MachineAutoSol

The Emerson logo is a trademark and service mark of Emerson Electric Co. All other marks are the property of their respective owners.
© 2020 Emerson Electric Co. All rights reserved.
00803-0001-0109-RevAA



CONSIDER IT SOLVED™