

Noctua LGA775 Mounting-Kit Installation Manual

Thank you very much for choosing a Noctua cooler. This manual will guide you through the installation process step by step.

Prior to installing the cooler, please consult the compatibility list on our website and verify that the cooler is fully compatible with your motherboard.

Should you encounter any difficulties, please check the FAQs on our website and don't hesitate to contact our support team at support@noctua.at. Noctua cannot be held responsible for any damage or losses caused by compatibility issues.

Multilingual versions of this manual are available on our website: www.noctua.at

Required mounting parts (from the LGA775-bag):



1x LGA backplate

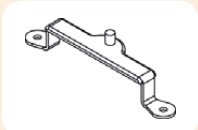

2x LGA mounting bars

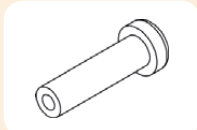

2x springscrews with internal thread

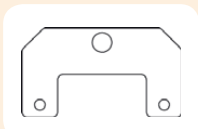

2x LGA fastening brackets



4x self-adhesive washers

Required mounting parts (from the common parts bag):

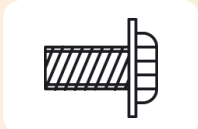

8x short screws



2x pressure springs

Step 1: Removing the mainboard

In case you want to use the NH-U12P on an assembled system, you first have to remove the mainboard from the case as the cooler has to be screwed together with the backplate on the back side of the mainboard.

Step 2: Attaching the backplate

Place the backplate on the back side of the mainboard, aligning

the backplate's screw sockets with the mainboard's screw-holes.

Caution: The insulation of the LGA backplate has to face the mainboard.

Caution: Don't forget to stick 4 self-adhesive washers to the mounting brackets.

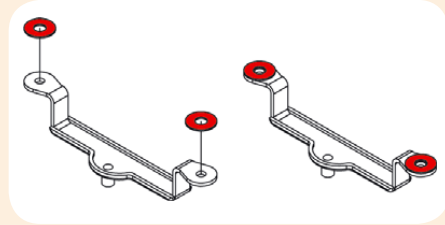

Choose the alignment of the mounting bars according to the desired final orientation of the cooler:

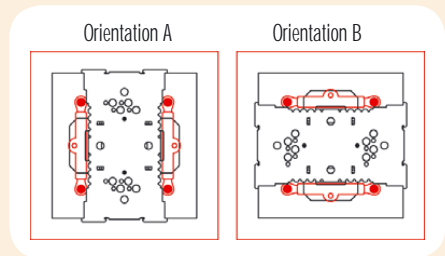

Caution: Make sure that the straight sides of the mounting bars face the socket and the bulgings are pointing outwards.

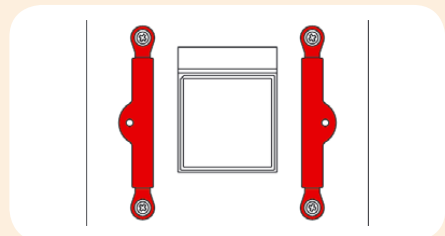

Now screw the mounting bars to the backplate using 4 short screws.

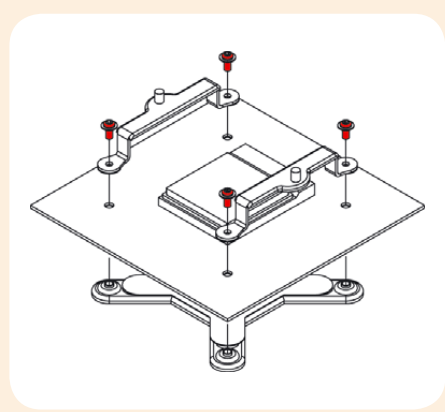

Step 3: Attaching the fastening brackets to the heatsink

Tightly screw the fastening brackets to the base of the heatsink using 4 short screws.

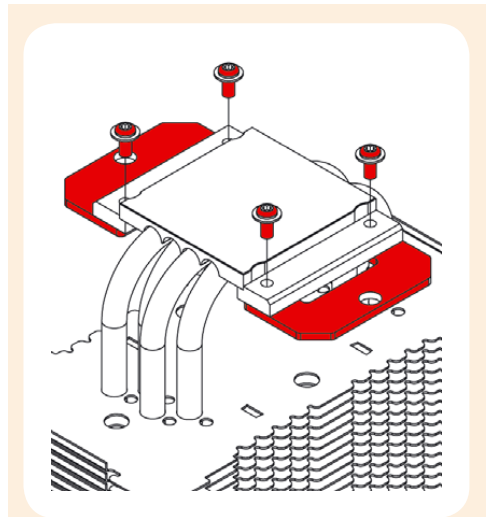

Step 4: Applying thermal paste

If there are residual traces of thermal paste or thermal pads on your CPU, please clean them off first.

Press a small drop (4-5mm diameter) of NT-H1 onto the centre of the heat-spreader.

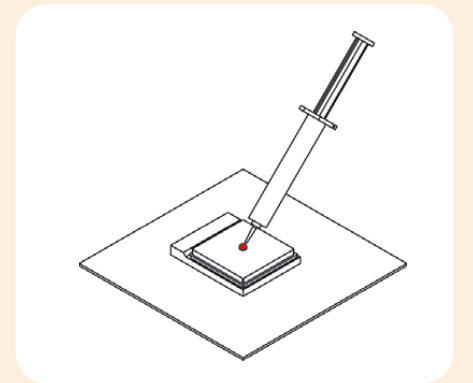

Caution: Applying too much thermal paste will lower the heat conductivity and cooling performance!

Caution: Take off the protection cover at the bottom side of the heatsink first!

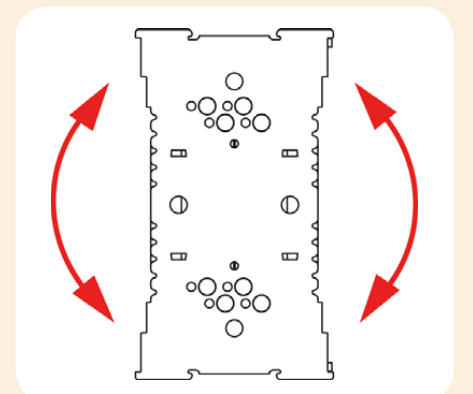

Put the heatsink onto the CPU and turn it back and forth a few times in order to spread the paste.



Step 5:
Attaching the heatsink to the CPU

Align the mounting holes of the fastening brackets with those of the mounting bars. Now screw the fastening brackets to the mounting bars employing the pressure springs and the respective screws.

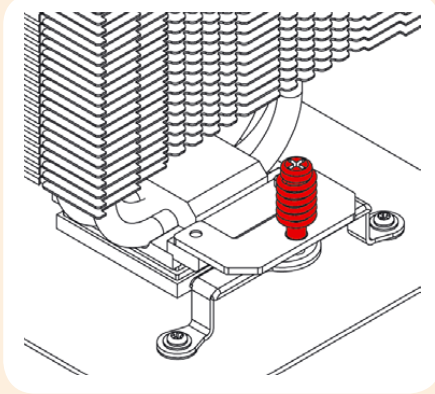

Caution: Tighten the screws until they stop.

Step 6:
Attaching the fan

First stick the 2 anti-vibration strips onto the cooling fins in order to dampen minor vibrations emitted by the fan.

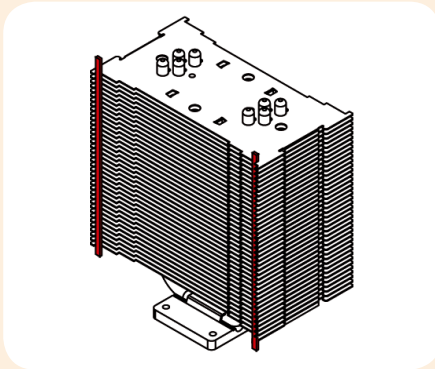

Then attach the fan to the heatsink using the 2 steel clips, placing it so that it blows onto the heatsink (You can optionally use the second pair of clips to install a second fan).

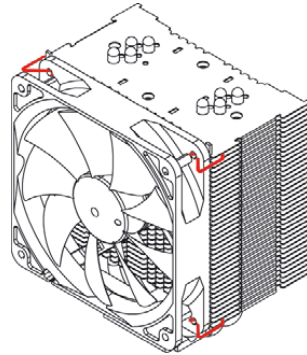
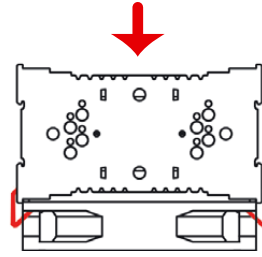
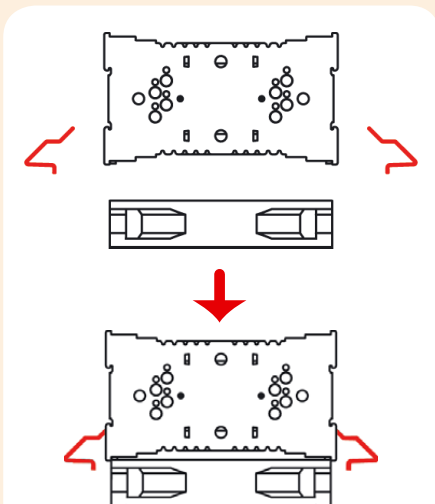

Connect the fan to the mainboard, power supply or fan controller. Depending on your CPU and the temperature inside the case, you may interconnect the supplied Low-Noise Adapter (L.N.A.) or Ultra-Low-Noise Adapter (U.L.N.A.) in order to further reduce the fan's operating noise.

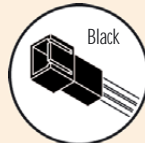

Black
Low-Noise Adapter (L.N.A.)
1100 RPM, 16.9 dB(A)

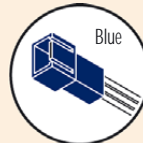

Blue
Ultra-Low-Noise Adapter (U.L.N.A.)
900 RPM, 12.6 dB(A)

Caution: When using the (U.)L.N.A., check the temperature of your CPU using appropriate software (e.g. the respective applications of your mainboard manufacturer), in order to evade automatic throttling of the CPU due to the increased temperature. If the cooling performance is insufficient, please increase case ventilation or remove the (U.)L.N.A.

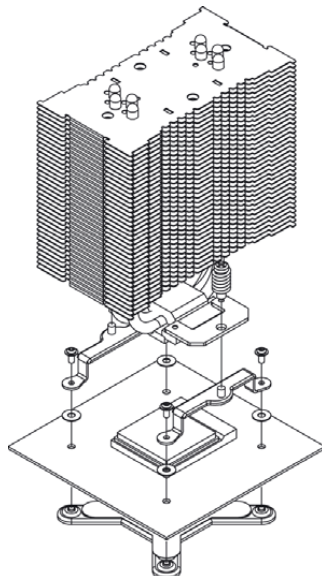

Warranty

Even with high-grade products and strict quality control, the possibility of defects cannot be eliminated entirely. Therefore, we aim at providing the highest possible level of dependability and convenience by offering a warranty period of 72 months and direct, fast and straightforward RMA service.

In case of warranty, you can either request RMA at your retailer or use our Direct RMA Service. For further information, please consult www.noctua.at. In order to process your RMA enquiry, we need a proof of purchase, so please don't forget to keep your invoice!

Please also note that any modifications to the cooler, fan or mounting parts will void your warranty.

Support & FAQs

For all enquiries concerning your Noctua cooler, both your retailer and the international Noctua support team at support@noctua.at are at your service.

Please also consult the FAQ section on our website www.noctua.at.



Noctua AM2(+) Mounting-Kit Installation Manual

Thank you very much for choosing a Noctua cooler. This manual will guide you through the installation process step by step.

Prior to installing the cooler, please consult the compatibility list on our website and verify that the cooler is fully compatible with your motherboard.

Should you encounter any difficulties, please check the FAQs on our website and don't hesitate to contact our support team at support@noctua.at. Noctua cannot be held responsible for any damage or losses caused by compatibility issues.

Multilingual versions of this manual are available on our website: www.noctua.at

Required mounting parts (from the AM2(+)-bag):

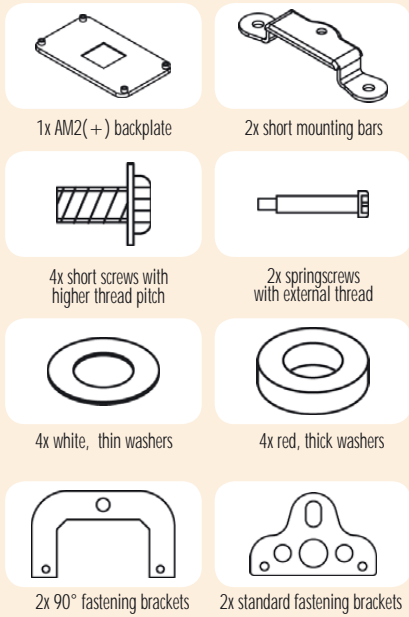

Required mounting parts (from the common parts bag):

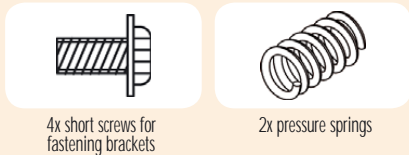

Step 1: Removing the mainboard and retention module

In case you want to use the NH-U12P on an assembled system, you first have to remove the mainboard from the case as the cooler has to be screwed together with the backplate on the back side of the mainboard.

If your mainboard uses a retention module for CPU cooler installation, you have to remove it first. Should you experience any difficulties, please consult your mainboard's manual. If your previous CPU cooler is attached using a different mounting mechanism, please remove it according to its manual.

Step 2: Attaching the backplate

Place the backplate on the back side of the mainboard, aligning the backplate's screw sockets with the mainboard's screwholes.

Caution: Make sure that the bulgings of the mounting bars are pointing towards the socket.

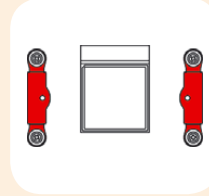

Put the 4 white, thin washers under the mounting bars and the 4 red, thick washers onto the mounting bars. Now screw the mounting bars to the backplate using the small screws with higher thread-pitch (from the AM2(+)-bag).

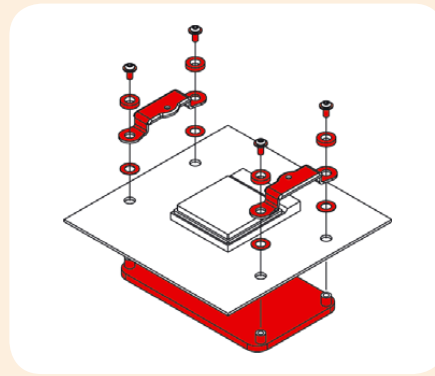

Step 3: Attaching the fastening brackets to the heatsink

Choose the fastening brackets according to the desired orientation of the cooler:

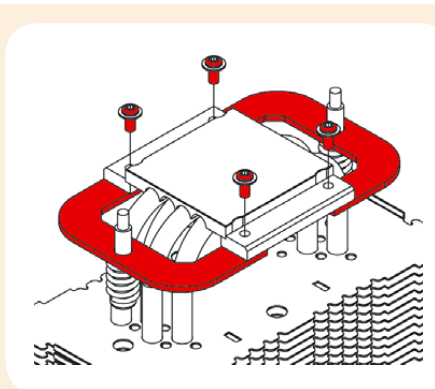
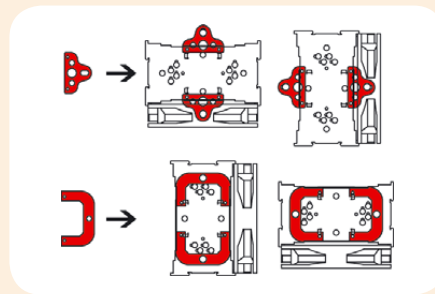

When using the 90° fastening brackets, first stick the spring screws and springs into the fastening brackets. Then screw them to the base of the heatsink tightly using 4 short screws.

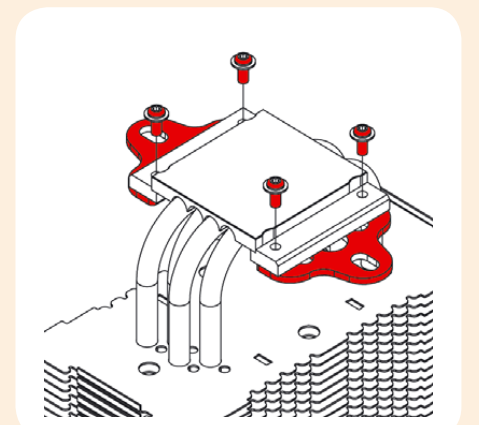

When using the standard fastening brackets, tightly screw them to the base of the heatsink using 4 short screws.

Step 4: Applying thermal paste

If there are residual traces of thermal paste or thermal pads on your CPU, please clean them off first.

Press a small drop (4-5mm diameter) of NT-H1 onto the centre of the heat-spreader.

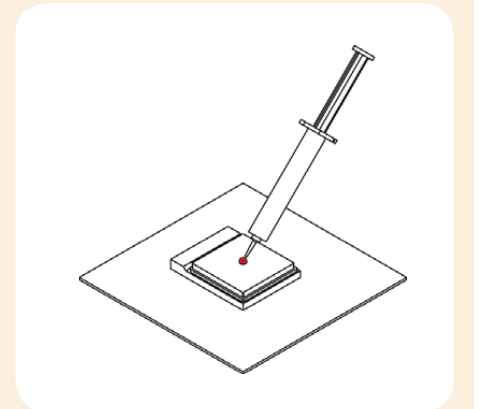

Caution: Applying too much thermal paste will lower the heat conductivity and cooling performance!

Caution: Take off the plastic cover at the bottom side of the heatsink first!

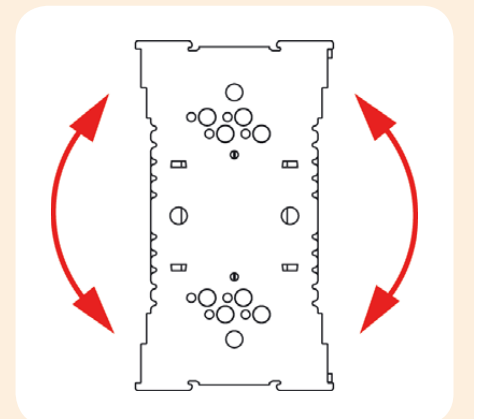

Put the heatsink onto the CPU and turn it back and forth a few times in order to spread the paste.



Step 5:
Attaching the heatsink to the CPU

Align the mounting holes of the fastening brackets with those of the mounting bars.

Now screw the fastening brackets to the mounting bars employing the pressure springs and the respective screws.

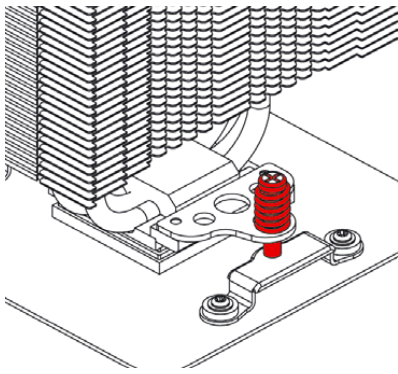

When employing the 90° fastening brackets, please use the supplied mounting-tool to tighten the springscrews.

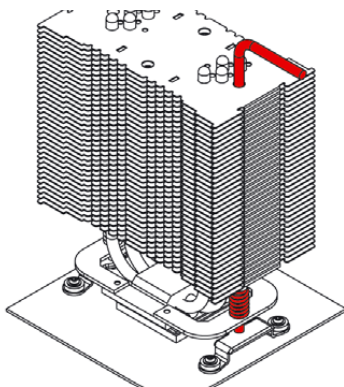

Caution: Tighten the screws until they stop.

Step 6:
Attaching the fan

First stick the 2 anti-vibration strips onto the cooling fins in order to dampen minor vibrations emitted by the fan.

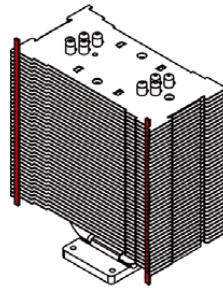

Then attach the fan to the heatsink using the 2 steel clips, placing it so that it blows onto the heatsink (You can optionally use the second pair of clips to install a second fan).

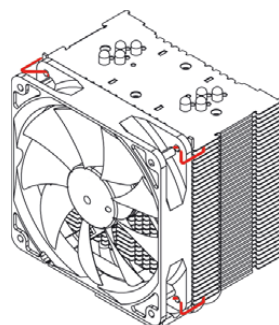
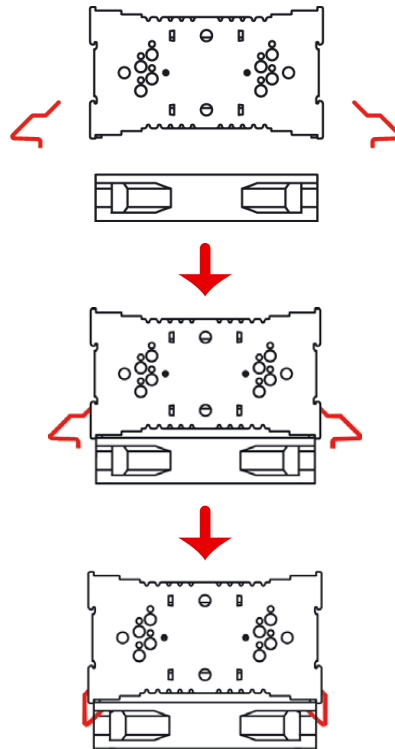

Connect the fan to the mainboard, power supply or fan controller. Depending on your CPU and the temperature inside the case, you may interconnect the supplied Low-Noise

Adapter (L.N.A.) or Ultra-Low-Noise Adapter (U.L.N.A.) in order to further reduce the fan's operating noise.

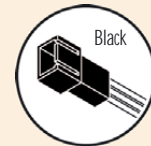

Low-Noise Adapter (L.N.A.)
1100 RPM, 16.9 dB(A)

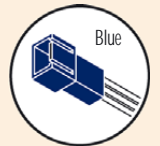

Ultra-Low-Noise Adapter (U.L.N.A.)
900 RPM, 12.6 dB(A)

Caution: When using the (U.)L.N.A., check the temperature of your CPU using appropriate software (e.g. the respective applications of your mainboard manufacturer), in order to evade automatic throttling of the CPU due to the increased temperature. If the cooling performance is insufficient, please increase case ventilation or remove the (U.)L.N.A.

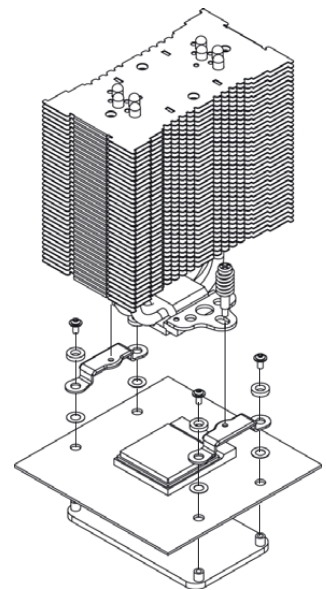

Warranty

Even with high-grade products and strict quality control, the possibility of defects cannot be eliminated entirely. Therefore, we aim at providing the highest possible level of dependability and convenience by offering a warranty period of 72 months and direct, fast and straightforward RMA service.

In case of warranty, you can either request RMA at your retailer or use our Direct RMA Service. For further information, please consult www.noctua.at. In order to process your RMA enquiry, we need a proof of purchase, so please don't forget to keep your invoice!

Please also note that any modifications to the cooler, fan or mounting parts will void your warranty.

Support & FAQs

For all enquiries concerning your Noctua cooler, both your retailer and the international Noctua support team at support@noctua.at are at your service.

Please also consult the FAQ section on our website www.noctua.at.