

# TASCAM

D01159020D

# DP-24

## Digital Portastudio

### OWNER'S MANUAL

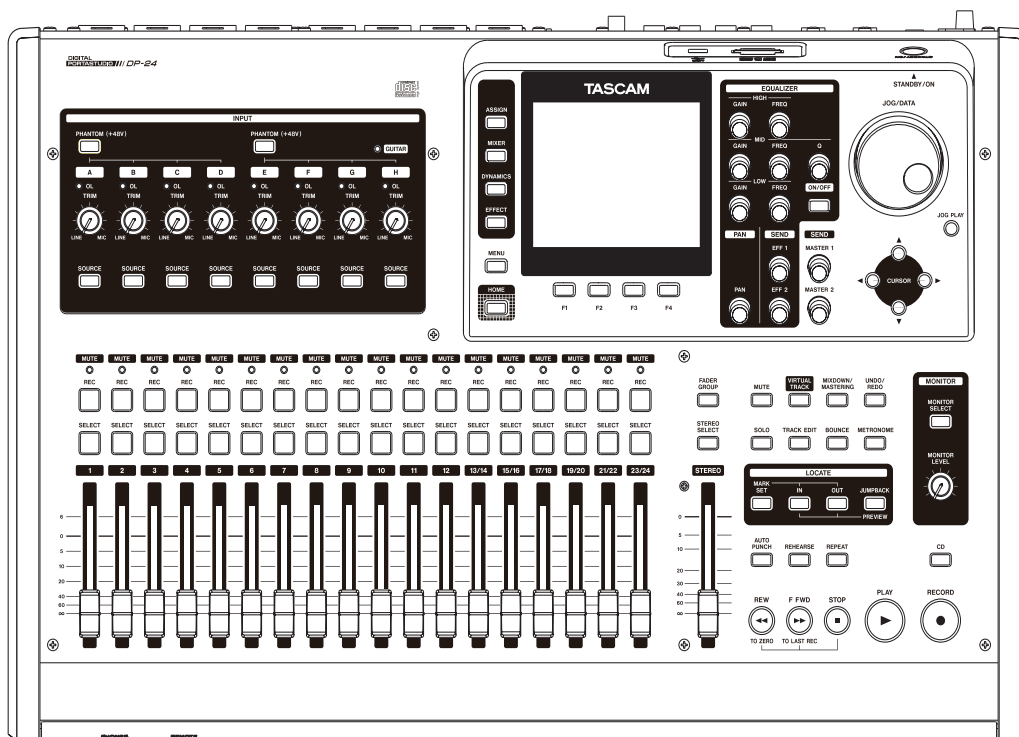

# IMPORTANT SAFETY PRECAUTIONS



**CAUTION**  
RISK OF ELECTRIC SHOCK  
DO NOT OPEN



**CAUTION:** TO REDUCE THE RISK OF ELECTRIC SHOCK, DO NOT REMOVE COVER (OR BACK). NO USER-SERVICEABLE PARTS INSIDE. REFER SERVICING TO QUALIFIED SERVICE PERSONNEL.



The lightning flash with arrowhead symbol, within equilateral triangle, is intended to alert the user to the presence of uninsulated "dangerous voltage" within the product's enclosure that may be of sufficient magnitude to constitute a risk of electric shock to persons.



The exclamation point within an equilateral triangle is intended to alert the user to the presence of important operating and maintenance (servicing) instructions in the literature accompanying the appliance.

**WARNING: TO PREVENT FIRE OR SHOCK HAZARD, DO NOT EXPOSE THIS APPLIANCE TO RAIN OR MOISTURE.**

## ■ For U.S.A.

### TO THE USER

This equipment has been tested and found to comply with the limits for a Class B digital device, pursuant to Part 15 of the FCC Rules. These limits are designed to provide reasonable protection against harmful interference in a residential installation. This equipment generates, uses, and can radiate radio frequency energy and, if not installed and used in accordance with the instruction manual, may cause harmful interference to radio communications. However, there is no guarantee that interference will not occur in a particular installation. If this equipment does cause harmful interference to radio or television reception, which can be determined by turning the equipment off and on, the user is encouraged to try to correct the interference by one or more of the following measures.

- a) Reorient or relocate the receiving antenna.
- b) Increase the separation between the equipment and receiver.
- c) Connect the equipment into an outlet on a circuit different from that to which the receiver is connected.
- d) Consult the dealer or an experienced radio/TV technician for help.

### CAUTION

Changes or modifications to this equipment not expressly approved by TEAC CORPORATION for compliance could void the user's authority to operate this equipment.

## ■ For European Customers

### Disposal of electrical and electronic equipment

- (a) All electrical and electronic equipment should be disposed of separately from the municipal waste stream via collection facilities designated by the government or local authorities.
- (b) By disposing of electrical and electronic equipment correctly, you will help save valuable resources and prevent any potential negative effects on human health and the environment.
- (c) Improper disposal of waste electrical and electronic equipment can have serious effects on the environment and human health because of the presence of hazardous substances in the equipment.
- (d) The Waste Electrical and Electronic Equipment (WEEE) symbol, which shows a wheeled bin that has been crossed out, indicates that electrical and electronic equipment must be collected and disposed of separately from household waste.



- (e) Return and collection systems are available to end users. For more detailed information about the disposal of old electrical and electronic equipment, please contact your city office, waste disposal service or the shop where you purchased the equipment.

## For Canada

THIS CLASS A DIGITAL APPARATUS COMPLIES WITH CANADIAN ICES-003.CET

APPAREIL NUMERIQUE DE LA CLASSE B EST CONFORME A LA NORME NMB-003 DU CANADA.

This appliance has a serial number located on the bottom panel. Please record the model number and serial number and retain them for your records.

Model number \_\_\_\_\_

Serial number \_\_\_\_\_

# IMPORTANT SAFETY INSTRUCTIONS

- 1 Read these instructions.
- 2 Keep these instructions.
- 3 Heed all warnings.
- 4 Follow all instructions.
- 5 Do not use this apparatus near water.
- 6 Clean only with dry cloth.
- 7 Do not block any ventilation openings. Install in accordance with the manufacturer's instructions.
- 8 Do not install near any heat sources such as radiators, heat registers, stoves, or other apparatus (including amplifiers) that produce heat.
- 9 Do not defeat the safety purpose of the polarized or grounding-type plug. A polarized plug has two blades with one wider than the other. A grounding type plug has two blades and a third grounding prong. The wide blade or the third prong are provided for your safety. If the provided plug does not fit into your outlet, consult an electrician for replacement of the obsolete outlet.
- 10 Protect the power cord from being walked on or pinched particularly at plugs, convenience receptacles, and the point where they exit from the apparatus.
- 11 Only use attachments/accessories specified by the manufacturer.
- 12 Use only with the cart, stand, tripod, bracket, or table specified by the manufacturer, or sold with the apparatus. When a cart is used, use caution when moving the cart/apparatus combination to avoid injury from tip-over.



- 13 Unplug this apparatus during lightning storms or when unused for long periods of time.
- 14 Refer all servicing to qualified service personnel. Servicing is required when the apparatus has been damaged in any way, such as power-supply cord or plug is damaged, liquid has been spilled or objects have fallen into the apparatus, the apparatus has been exposed to rain or moisture, does not operate normally, or has been dropped.

- The apparatus draws nominal non-operating power from the AC outlet with its POWER or STANDBY/ON switch not in the ON position.
- The mains plug is used as the disconnect device, the disconnect device shall remain readily operable.
- Caution should be taken when using earphones or headphones with the product because excessive sound pressure (volume) from earphones or headphones can cause hearing loss.

## CAUTION

- Do not expose this apparatus to drips or splashes.
- Do not place any objects filled with liquids, such as vases, on the apparatus.
- Do not install this apparatus in a confined space such as a book case or similar unit.
- The apparatus should be located close enough to the AC outlet so that you can easily grasp the power cord plug at any time.
- If the product uses batteries (including a battery pack or ooinstalled batteries), they should not be exposed to sunshine, fire or excessive heat.
- CAUTION for products that use replaceable lithium batteries: oothere is danger of explosion if a battery is replaced with an incorrect type of battery. Replace only with the same or equivalent type.

## WARNING

Products with Class I construction are equipped with a power supply cord that has a grounding plug. The cord of such a product must be plugged into an AC outlet that has a protective grounding connection.

# Safety Information

## CAUTIONS ABOUT LASER RADIATION

This product has been designed and manufactured according to FDA regulations "title 21, CFR, chapter 1, subchapter J, based on the Radiation Control for Health and Safety Act of 1968," and is classified as a class 1 laser product. There is no hazardous invisible laser radiation during operation because invisible laser radiation emitted inside of this product is completely confined in the protective housings.

The label required in this regulation is shown at ①.

### Optical pickup

Type : SW651L  
 Manufacturer : Hitachi Media Electronics Co., Ltd.  
 Laser output : Less than 95mW on the objective lens  
 Wavelength : 785 nm (Typ.)  
 Standard : IEC60825-1: 2007

①

For USA

CERTIFICATION - THIS PRODUCT COMPLIES WITH 21 CFR 1040.10 AND 1040.11 EXCEPT FOR DEVIATIONS PURSUANT TO LASER NOTICE NO.50, DATED JUNE 24, 2007.

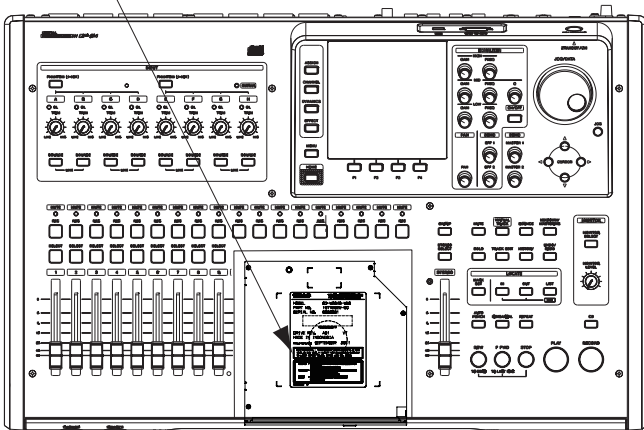

### Cautions:

- DO NOT REMOVE THE PROTECTIVE HOUSING USING A SCREWDRIVER.
- USE OF CONTROLS OR ADJUSTMENTS OR PERFORMANCE OF PROCEDURES OTHER THAN THOSE SPECIFIED HEREIN MAY RESULT IN HAZARDOUS RADIATION EXPOSURE.
- IF THIS PRODUCT DEVELOPS TROUBLE, CONTACT YOUR NEAREST QUALIFIED SERVICE PERSONNEL, AND DO NOT USE THE PRODUCT IN ITS DAMAGED STATE.

### 产品有毒有害物质或元素的名称及含量

机种: DP-24		有毒有害物质或元素					
	品名	铅 (Pb)	汞 (Hg)	镉 (Cd)	六价铬 (Cr (VI))	多溴联苯 (PBB)	多溴二苯醚 (PBDE)
1	CHASSIS部份	○	○	○	○	○	○
2	PCB Assy部份	×	○	○	○	○	○
3	线材部份	○	○	○	○	○	○
4	附属品部份	×	○	○	○	○	○
5	SEAL部份	○	○	○	○	○	○
6	包装部份	○	○	○	○	○	○

○: 表示该有毒有害物质在该部件所有均质材料中的含量均在 SJ/T11363-2006 标准规定的限量要求以下。

×: 表示该有毒有害物质至少在该部件的某一均质材料中的含量超出 SJ/T11363-2006 标准规定的限量要求。

(针对现在代替技术困难的电子部品及合金中的铅)



# Table of Contents

<b>1 – Introduction .....</b>	<b>8</b>	Start-up & Shutdown .....	35
Features .....	8	Starting up the unit .....	35
Items included with the product .....	8	Shutting down .....	35
Conventions used in this manual .....	8	Setting the date and time .....	35
Intellectual property rights .....	9	Preparing an SD card for use .....	36
Precautions for placement and use .....	9	Recorder modes .....	36
Beware of condensation .....	9	Connecting other equipment .....	36
Cleaning the unit .....	9	Front panel .....	36
About SD cards .....	9	Rear panel .....	37
Precautions for use .....	10	Adjusting the contrast .....	37
About CDs (Compact Discs) .....	10	<b>5 - Song Management .....</b>	<b>38</b>
Precautions for use .....	10	Editing names .....	38
About CD-R and CD-RW discs .....	10	Loading a song .....	38
<b>2 - Quick Guide .....</b>	<b>12</b>	Creating a new song .....	38
Playback and mixing .....	12	Saving a song .....	39
Preparation .....	12	Viewing song information .....	40
Listening to the demo song .....	13	Copying songs .....	40
Recording and mastering .....	14	Erasing songs .....	41
Creating a new song .....	14	Protecting songs .....	41
Connecting and setting the input sources .....	15	Deleting unnecessary audio data from a song .....	42
Setting the guitar as the recording source for TRACK 1 .....	15	Changing a song name .....	43
Adjusting and monitoring the input level .....	15	<b>6 - Basic Recording .....</b>	<b>44</b>
Recording a guitar to TRACK 1 .....	16	Selecting the input sources .....	44
Playing back the recording .....	16	Assigning inputs .....	44
Recording a guitar to TRACK 2 .....	16	Assigning to a mono track .....	44
Recording a vocal to TRACK 3 .....	17	Assigning to a stereo track .....	44
Mixing the tracks .....	18	Assigning to a stereo bus .....	44
Mastering a recording .....	19	Checking the assignment .....	45
Creating an audio CD with the master file .....	21	Canceling an assignment .....	45
Inserting a CD .....	21	Using phantom power .....	45
Writing to a CD-R/CD-RW .....	22	Monitoring .....	45
Ejecting a CD .....	23	Monitor selection .....	45
Shutting down .....	23	OL indicators and level meters .....	46
<b>3 – Names and Functions of Parts .....</b>	<b>24</b>	Setting the Mixer screen .....	46
Top panel .....	24	Using EQ (equalizer) .....	46
Front panel .....	28	DIGITAL TRIM setting (Track only) .....	47
Rear panel .....	29	Built-in Send Effects and External Effects .....	47
Home screen .....	30	Setting built-in effects .....	47
Menu structure .....	31	Setting the stereo position .....	48
Screen operations .....	32	Changing the signal phase .....	48
<b>4 – Preparation .....</b>	<b>34</b>	Checking the fader level .....	48
Inserting and removing SD cards .....	34	Solo .....	48
Inserting an SD card .....	34	Muting tracks .....	48
Removing the card .....	34	Rehearsing the recording .....	49
About write-protected SD cards .....	34	Making the first recording .....	49
Powering the unit .....	34		

# Table of Contents

Multitrack recording .....	50	COPY/PASTE .....	61
Setting the tracks for recording .....	50	COPY/INSERT .....	61
Setting track pan and level .....	50	MOVE/PASTE .....	62
Input selection and assignment .....	50	MOVE/INSERT .....	62
Setting input levels .....	50	OPEN (Insert Silence) .....	62
Recording .....	50	CUT (Remove Part) .....	62
Undoing an operation .....	50	SILENCE (Erase Part) .....	63
Setting the undoing feature .....	50	CLONE TRACK (Track Duplication) .....	63
Undoing the last operation (single undo) .....	51	CLEAN OUT (Delete Track) .....	63
Undoing previous operations (multi-undo) .....	51		
<b>7 - Recorder Functions .....</b>	<b>52</b>	<b>9 - Using Built-In Effects .....</b>	<b>64</b>
Punching in and out .....	52	Dynamic effects .....	64
Using a foot switch to punch in/out .....	52	Inserting a dynamic effect .....	64
Setting the foot switch .....	52	Editing a dynamic effect .....	64
Bouncing tracks .....	53	Guitar effects .....	64
Performing the track bouncing .....	53	Inserting a guitar effect .....	64
Checking the result .....	53	Editing guitar effects .....	65
Direct Location Function .....	54	Calling effects from the guitar effect library .....	65
Locating directly a specified time .....	54	Saving guitar effects in the library .....	65
Locating directly a specified measure/beat .....	54	Send effects .....	65
Location marks .....	54	Using send effects .....	65
Setting a location mark .....	54	Editing send effects .....	65
Skipping to location marks .....	55	Calling the send effect library .....	66
Deleting a location mark .....	55	Saving send effects in the library .....	66
Returning to zero (TO ZERO) and returning to last recording position (TO LAST REC) .....	55		
Fast forward/rewind search .....	55	<b>10 - Mixing Down and Mastering Tracks .....</b>	<b>68</b>
Jog positioning .....	55	Mixing down tracks .....	68
Viewing the track's waveform .....	55	Levels and balance .....	68
Listening to the track sounds .....	55	Fader group .....	68
Repeat playback .....	56	Stereo position (panning) .....	68
Setting IN/OUT points .....	56	TRACK EQ (equalizer) .....	68
Using repeat playback .....	56	Send effects .....	69
Moving back a few seconds for replay (jump back playback) .....	56	Creating a master file .....	69
Checking cueing points (preview) .....	57	Setting the start and end points .....	69
Auto punch in/out .....	57	Creating a master file .....	70
Setting punch in/out points .....	58	Exiting Mixdown mode .....	70
Checking punch in/out points .....	58	Checking the master file .....	70
Rehearsing punch in/out .....	58	Ending master file checking .....	71
Performing auto punch in/out .....	59	Finishing up a master file (mastering) .....	71
Checking a take .....	59	Mastering procedures .....	71
Virtual tracks .....	59	Using the mastering EQ (equalizer) .....	71
		Using mastering compression .....	72
		Using normalize .....	73
		Using the noise shaper (Noise Shaped Dithering) .....	73
		Exiting Mastering mode .....	73
<b>8 - Track Editing .....</b>	<b>60</b>		
Overview of track editing .....	60		
Editing points .....	60		
Basic editing procedures .....	60		
Explanation of items .....	60		

<b>11 - Various Other Functions.....</b>	<b>74</b>	<b>17 – Specifications .....</b>	<b>97</b>
Metronome .....	74	Ratings .....	97
MIDI Sync .....	74	Input/output ratings.....	97
MIDI remote control.....	75	Analog audio input/output ratings .....	97
Tuner function.....	75	Control input/output ratings .....	97
Setup (PREFERENCE) .....	76	Audio performance .....	97
Auto Monitor .....	76	Operating requirements.....	97
Restoring the initial preference settings .....	77	General.....	98
Viewing information .....	77	Dimensional drawings .....	98
<b>12 - SD Card Management.....</b>	<b>78</b>	Block diagram.....	99
Quick formatting an SD card.....	78	Level diagram .....	100
Full formatting an SD card .....	79	<b>18 – Appendix .....</b>	<b>101</b>
<b>13 - Exchanging Data with a Computer.....</b>	<b>80</b>	MIDI Control Change message .....	101
Operating system requirements.....	80	Mixer control change parameters.....	101
Connecting to a computer .....	80	MIDI Program Change message .....	102
Disconnecting .....	81	Dynamic effects .....	102
Track import and export.....	82	Preset libraries of the send effects .....	102
Importing tracks .....	82	Preset libraries of the guitar effects.....	102
Exporting tracks.....	83	MIDI Implementation Chart .....	103
Deleting files from the AudioDepot folder.....	83	Bit-map array of MMC command .....	104
<b>14 - Using CDs.....</b>	<b>84</b>		
Using the CD drive.....	84		
Preparations before using CDs with this unit ..	84		
Types of CDs that can be used with this unit...84			
Loading and ejecting CDs.....	85		
Loading a CD.....	85		
Ejecting a CD.....	86		
Forcing disc ejection .....	86		
Playing back an Audio CD.....	86		
Creating an Audio CD.....	87		
Using Disc At Once .....	87		
Using Track At Once .....	88		
Using LIVE WRITER .....	89		
Finalizing a CD.....	90		
Importing songs from an Audio CD.....	90		
Erasing a CD-RW .....	91		
Media Compatibility Table.....	91		
<b>15 – Troubleshooting.....</b>	<b>92</b>		
<b>16 – Messages .....</b>	<b>93</b>		
General messages.....	93		
CD mode messages.....	95		
CD-related error messages .....	96		

# 1 – Introduction

Thank you very much for purchasing the TASCAM DP-24 Digital Portastudio.

Before connecting and using the unit, please take time to read this manual thoroughly to ensure you understand how to properly set up and connect the unit, as well as the operation of its many useful and convenient functions. After you have finished reading this manual, please keep it in a safe place for future reference.

You can also download the Owner's Manual from the TASCAM website (<http://tascam.com/>).

---

## Features

---

This unit uses SD cards for multitrack recording of up to 8 tracks and playback of up to 24 tracks simultaneously. Multiple tracks can be mixed down to stereo to create a master file by using the built-in mixer functions.

Master files can be written to CD-Rs and similar media, as well as transferred to a computer that is connected via USB. Moreover, since transferring data between the unit and a computer is possible, you can copy tracks and master files, and back up song files to a computer.

- Your 24-Track DIGITAL PORTASTUDIO uses SD cards as recording media and includes a CD drive
- Supports SDHC standards for large capacity SD cards of up to 32GB
- Multitrack recorder functions include simultaneous 8 track recording + 24 track playback (44.1/48kHz, 16/24bit)
- 18+1 45mm faders (for track and master level adjustment)
- Each track has independent **SELECT** button and **REC** button
- +48V Phantom power supported mic input
- Eight balanced mic/line inputs (XLR/TRS combo jacks)
- High-impedance guitar input supported (INPUT H only: 6.3mm (1/4") TS phone jack)
- 3.5-inch large TFT color LCD display
- Independent 3-band equalizers for each input and playback track
- Mixing down to a dedicated master file possible
- Included mastering effects can be used on mix downs of master files
- Includes Reverb and various other effects that can be independently adjusted for each playback track
- Auto punch in/out function
- Track bounce function
- Track editing functions include COPY INSERT, COPY PASTE, MOVE INSERT, MOVE PASTE, OPEN, CUT, SILENCE, CLONE TRACK, and CLEAN OUT
- Undo and redo functions, including history level setting
- Locate Mark function

- Tuner and metronome functions
- Audio CDs can be created from mixed down master files, and tracks on Audio CDs can be played back and imported
- Song data and WAVE files can be copied and backed up to a computer connected via USB2.0
- Punch in/out and other functions can be assigned to and controlled by a foot switch (TASCAM RC-3F, sold separately)

---

## Items included with the product

---

The DP-24 package contains the following items.

Take care when opening the package not to damage the items. Keep the package materials for transportation in the future.

Please contact the store where you purchased this unit if any of these items are missing or have been damaged during transportation.

- Main unit..... 1
- AC adapter (TASCAM PS-1225L)..... 1
- Power cord for AC adapter ..... 1
- SD memory card (inserted into the unit) ..... 1
- USB cable (80cm) ..... 1
- Warranty card..... 1
- Owner's Manual (this manual)..... 1

### CAUTION

Never use any AC adapter or power cord other than the supplied TASCAM PS-1225L AC adapter and AC adapter power cord. Moreover, do not use the supplied AC adapter and AC adapter power cord with other equipment. Doing so could cause malfunction, fire or electric shock.

---

## Conventions used in this manual

---

Conventions used in this manual are as follows.

- Names of buttons, controls, etc. of this unit appear like this: **MENU**.
- Text displayed on the LCD display appears like this: MENU.
- The four buttons beneath the LCD display (**F1** to **F4**) are function buttons. The functions displayed at the bottom of each screen are sometimes shown after the button names in parentheses.  
Example: **F1** (TIMELINE) button, **F4** (▶) button.
- "SD memory card" is abbreviated as "SD card".
- CD-DA format may be mentioned as Audio CD format. Moreover, a CD recorded with Audio CD format tracks may be mentioned as an Audio CD.
- An unused CD-R/CD-RW or a completely erased CD-RW may be mentioned as a blank CD.
- Text displayed on a computer monitor appears like this: OK.

- Additional information is introduced in the following styles when needed: TIP, NOTE, and CAUTION.

## **TIP**

Useful hints when using the unit.

## **NOTE**

Explanation of actions in special situations, supplementary explanations, etc.

## **CAUTION**

Instructions that should be followed to avoid injury, damage to the unit or other equipment, and loss of data.

---

## Intellectual property rights

---

- TASCAM is a trademark of TEAC Corporation, registered in the U.S. and other countries.
- SDHC Logo is a trademark of SD-3C, LLC.



- Microsoft, Windows, Windows XP, Windows Vista, and Windows 7 are either registered trademarks or trademarks of Microsoft Corporation in the United States and/or other countries.
- Apple, Macintosh, iMac, Mac OS and Mac OS X are trademarks of Apple Inc.
- Pentium and Intel are trademarks of Intel Corporation in the U.S. and/or other countries.
- Other company names, product names and logos in this document are the trademarks or registered trademarks of their respective owners.

Any data, including, but not limited to information, described herein are intended only as illustrations of such data and/or information and not as the specifications for such data and/or information. TEAC Corporation disclaims any warranty that any use of such data and/or information shall be free from infringement of any third party's intellectual property rights or other proprietary rights, and further, assumes no liability of whatsoever nature in the event of any such infringement, or arising from or connected with or related to the use of such data and/or information.

This product is designed to help you record and reproduce sound works to which you own the copyright, or where you have obtained permission from the copyright holder or the rightful licensor. Please use the product appropriately.

Under no circumstances will TEAC Corporation be responsible for the consequences of any illegal copying performed using the recorder.

---

## Precautions for placement and use

---

- The operating temperature should be between 5°C and 35°C (41°F and 95°F).
- Do not install in the following types of places. Doing so could degrade the sound quality and/or cause malfunctions.
  - Places with significant vibrations or that are otherwise unstable
  - Near windows or other places exposed to direct sunlight
  - Near heaters or other extremely hot places
  - Extremely cold places
  - Places with bad ventilation or high humidity
  - Very dusty locations
- Make sure that the unit is mounted in a level position for correct operation.
- Do not place any object on the unit for heat dissipation.
- Avoid installing this unit on top of any heat-generating electrical device such as a power amplifier.

---

## Beware of condensation

---

If the unit is moved from a cold to a warm place, or used after a sudden temperature change, there is a danger of condensation; vapor in the air could condense on the internal mechanism, making correct operation impossible. To prevent this, or if this occurs, let the unit sit for one or two hours at the new room temperature before using.

---

## Cleaning the unit

---

Use a dry soft cloth to wipe the unit clean. Do not clean the unit with a chemically treated cloth or substances such as benzine, thinner and alcohol. This could damage the surface or change the color of the unit.

---

## About SD cards

---

This unit uses SD cards for recording and playback.

SD and SDHC cards that are at least 512 MB in size can be used.

A list of SD cards that have been tested with this unit can be found on the TASCAM website (<http://tascam.com/>). Use of cards that have not been verified for use with this unit could result in the unit not functioning properly.

# 1 – Introduction

## Precautions for use

SD cards are delicate media. In order to avoid damaging a card or the card slot, please take the following precautions when handling them.

- Do not leave them in extremely hot or cold places.
- Do not leave them in extremely humid places.
- Do not let them get wet.
- Do not put things on top of them or twist them.
- Do not hit them.
- Do not remove or insert an SD card when the power is ON.

## About CDs (Compact Discs)

In addition to Audio CDs, this unit can play CD-R and CD-RW discs on which Audio CD (CD-DA) format files are recorded. The unit can also play 8cm CDs.

## Precautions for use

- Use only CD, CD-R and CD-RW discs that bear the following logos.

### CD-R



### CD-RW



- Always place the compact discs in the trays with their label facing upward.
- To remove a disc from its case, press down on the center of the disc holder, then lift the disc out, holding it carefully by the edges.
- Do not touch the signal side (the unlabeled side). Fingerprints, oils and other substances can cause errors during recording.
- To clean the signal side of a disc, wipe gently with a soft dry cloth from the center towards the outside edge. Dirt on discs can lower the sound quality, so clean them and always store them in a clean state.
- Do not use any record spray, anti-static solutions, benzene, paint thinner or other chemical agents to clean CDs. This could damage the delicate playing surface and cause CDs to become unplayable.

- Do not apply labels or other materials to discs. Do not use discs that have had tape, stickers or other materials applied to their surface. Do not use discs that have sticky residue from stickers, etc. Such discs could become stuck in the unit or cause it to malfunction.
- Never use a commercially available CD stabilizer. Using stabilizers with this unit will damage the mechanism and cause it to malfunction.
- Do not use cracked discs.
- Only use circular compact discs. Do not use non-circular promotional, etc. discs.

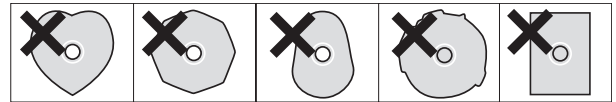

- Some record companies sell copy-protected discs or copy-controlled discs that may not play back correctly in this unit. Since such discs may not conform with the CD standard, do not use them in this unit.
- If you experience problems with such non-standard discs, you should contact the producers of the disc.

## About CD-R and CD-RW discs

CD-R discs can be recorded only once. Tracks (songs) recorded in such discs cannot be deleted. However, if the disc has not been finalized and sufficient space is available on the disc, additional material can be recorded. After finishing recording, finalizing a CD-R makes it playable in most ordinary CD players (some CD players might not be able to play these discs).

If a CD-RW disc becomes full, you can erase the recorded data to allow reuse.

However, you cannot designate specific songs for erasure. Even after being finalized, CD-RW discs can only be played in players that specifically support their playback.





# 2 - Quick Guide

## Playback and mixing

In this section, we will play back the demo song on the included SD card.

When this unit is purchased new, the SD card with the demo song on it is already installed in the unit, but we will start by explaining how to insert an SD card using the procedures below.

### Preparation

1. Insert the included SD card into the SD card slot on the rear panel. Be careful not to forcibly insert the card in the wrong direction. Doing so could damage the SD card slot or the SD card.

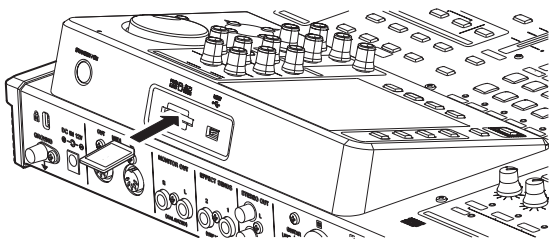

2. Connect the supplied AC adapter (TASCAM PS-1225L) to the DC IN 12V jack on the rear panel.

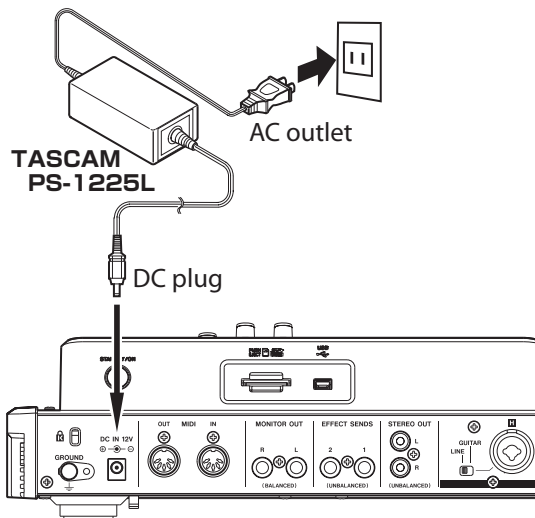

The bottom panel has a hook (cord holder) that can be used to hold the AC adapter cord in place. When using it, wrap the cord around this cord holder to prevent it from being disconnected during use.

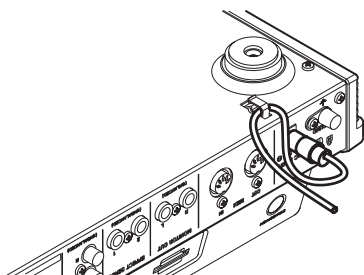

### CAUTION

Never use any AC adapter or power cord other than the supplied TASCAM PS-1225L AC adapter and AC adapter power cord. Use of a different adapter could cause malfunction, fire or electric shock.

3. Connect headphones to the PHONES jack on the front panel.

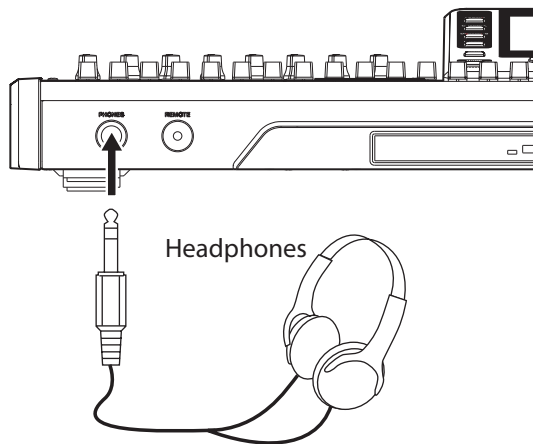

4. Press and hold the STANDBY/ON button for a few seconds on the rear panel to turn the power ON. When the unit starts, the Home screen appears on the display.

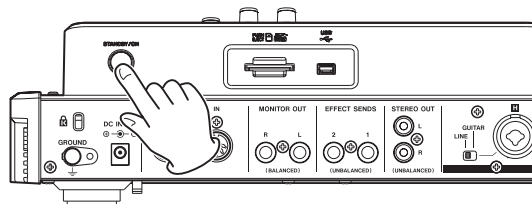

Start-up screen

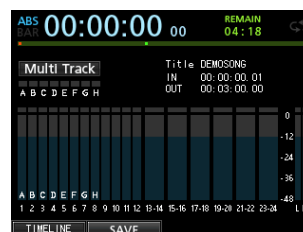

Home screen

### CAUTION

- Do not remove or insert an SD card when the power is ON. Always turn the power OFF (standby) before removing or inserting an SD card.

- When the power is on, do not cut the power to the unit by, for example disconnecting the power cord. All settings made since the last time you saved will not be saved. If you cut the power while an SD card is being accessed, all recorded songs and data may be damaged and cannot be recovered.
- Before turning the power ON, minimize the headphones volume and the volume on any monitoring system connected to this unit.

### TIP

If an amplifier or powered speakers are connected to the **MONITOR OUT** jacks, you can monitor using speakers.

## Listening to the demo song

The included SD card in the unit contains a demo song. We will use this demo song to practice listening to and mixing a recording.

1. Press the **HOME** button to open the Home screen.

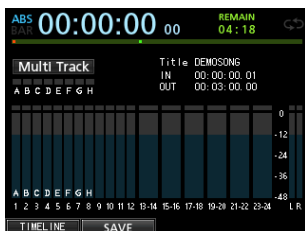

2. When the recorder is stopped, press the **MENU** button to open the MENU screen.



3. Use the **JOG/DATA** dial or the **CURSOR** (▲/▼/◀/▶) buttons to select (green highlight) **SONG**, and then press the **F4** (▶) button.

The **SONG LIST** screen appears.

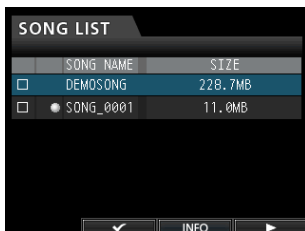

4. Use the **JOG/DATA** dial or the **CURSOR** (▲/▼) buttons to select **DEMO SONG**, and then press the **F4** (▶) button to open a sub-menu.



5. Use the **JOG/DATA** dial or the **CURSOR** (▲/▼) buttons to select **LOAD**, and then press the **F4** (▶) button.

The **SONG LOAD** pop-up window appears.

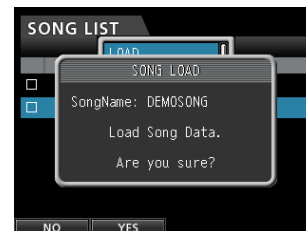

6. Press the **F2** (YES) button to load the demo song.

The demo song is loaded and the display returns to the **SONG LIST** screen.

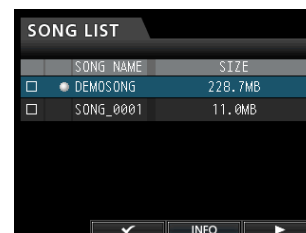

7. Press the **HOME** button to return to the Home screen.

8. Press the **PLAY** (▶) button, and raise the **TRACK 1** to **23/24** faders, the **STEREO** fader and the **MONITOR LEVEL** knob to listen to the demo song.

The **STEREO** fader adjusts the overall volume of **TRACK 1** to **23/24**. The standard position of the **STEREO** fader is **0dB**.

Use **TRACK 1** to **23/24** faders to adjust the balance of the tracks.

Use the **MONITOR LEVEL** knob to adjust the final monitoring volume.

9. Press the **MIXER** button to open the Mixer screen.

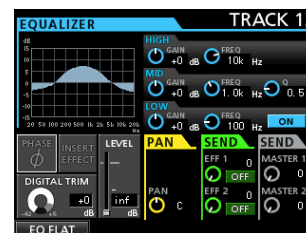

10. Press the **SOURCE** button to select **INPUT A** to **H**, or press the **SELECT** button to select a track to be set, and then use the **PAN** knob to set the stereo signal position of each track.

## 2 - Quick Guide

### TIP

- Press the **STOP** (■) and **REW** (◀◀) (**TO ZERO**) buttons at the same time to return to the beginning of the song (ZERO point) (**TO ZERO** function).
- If you press the wrong button and open a different screen, press the **HOME** button to return to the Home screen at any time.

## Recording and mastering

In this section we will practice multitrack recording.

Here we will explain how to connect an electric guitar and rhythm guitar to **INPUT H**, and an external microphone to **INPUT B**.

In the following example, we will explain how to record a rhythm guitar part with an electric guitar to track 1 and a lead guitar part to track 2. Then, we will use the external microphone to record vocals to track 3. Finally, we will mix down the tracks to stereo.

We will assume that you have already followed the instructions in the previous section, and that you have connected the monitoring equipment, started the unit and inserted the SD card.

## Creating a new song

1. When the recorder is stopped, press the **MENU** button to open the **MENU** screen.



2. Use the **JOG/DATA** dial or the **CURSOR** (▲/▼/◀/▶) buttons to select (green highlight) **SONG**, and then press the **F4** (▶) button.

The **SONG LIST** screen appears.

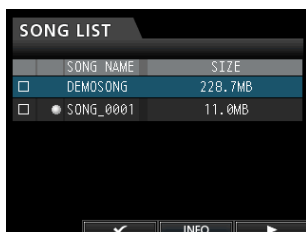

3. Press the **F4** (▶) button to open the sub-menu and then use the **JOG/DATA** dial or the **CURSOR** (▲/▼) buttons to select **CREATE**.

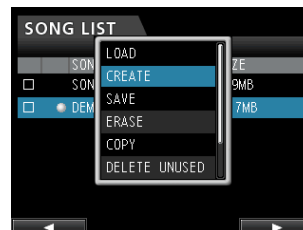

4. Press the **F4** (▶) button to open the **SONG CREATE** pop-up window.

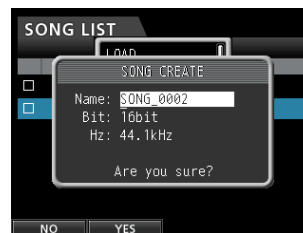

The created song is given the name **SONG\_0002**.

5. Change the name (title) of the song as necessary in the item **Name**. (See "Editing names" on page 38.)
6. Use the **CURSOR** (▲/▼) buttons to move the cursor (blue highlight) to select **Bit** (Bit rate), **Hz** (Sampling frequency), and then use the **JOG/DATA** dial to set.

### CAUTION

When creating a CD from a master file, set to 44.1kHz, 16bit.

7. Press the **F2** (YES) button.

The currently loaded song is saved and a new song is created.

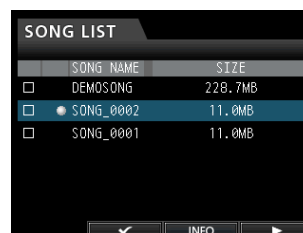

8. Press the **HOME** button to return to the Home screen.

## Connecting and setting the input sources

1. Connect an electric guitar to the MIC/LINE INPUTS H jack on the rear panel.

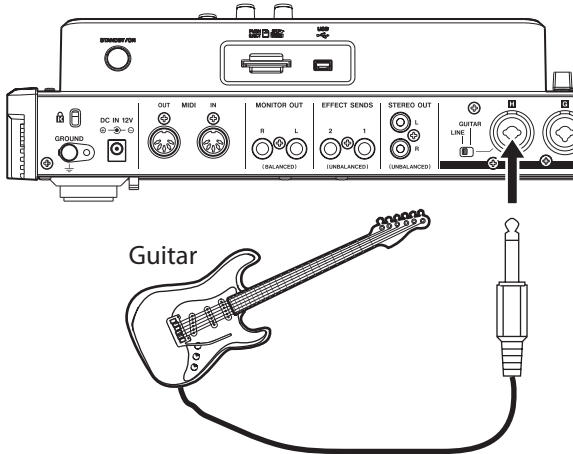

2. Set the LINE-GUITAR switch to GUITAR on the rear panel.

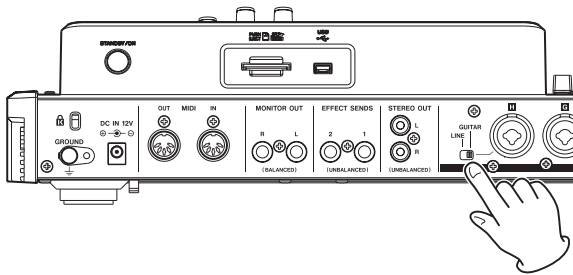

The **GUITAR** indicator lights.

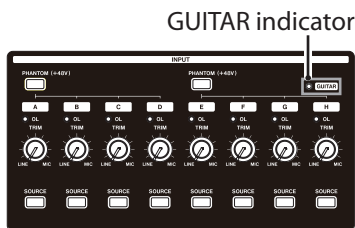

Now the guitar becomes the input source for INPUT H.

### TIP

When connecting an electric-acoustic guitar with a built-in preamp or an active-type electric guitar, or when using an effects pedal, for example, between the guitar and this unit, set the **LINE-GUITAR** switch to **LINE** on the rear panel.

## Setting the guitar as the recording source for TRACK 1

When you press the **ASSIGN** button to open the Assign screen, the default screen setting for the recording source is **A** (INPUT A) for TRACK 1, **B** (INPUT B) for TRACK 2, **C** (INPUT C) for TRACK 3, and so on for **D** to **H** (INPUT D to H) for TRACK 4 to 8. (See "Assigning inputs" on page 44.)

Since initially the input source of the INPUT H is set as the recording source of the TRACK 8, you must change the recording source to TRACK 1.

Follow the procedure below to change the recording source of the TRACK 1.

1. Press the **ASSIGN** button to open the Assign screen.

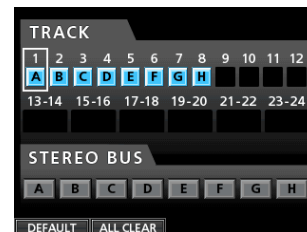

2. Use the **CURSOR** (**▲**/**▼**/**◀**/**▶**) buttons or press the **SELECT** button for **TRACK 1** and align the cursor (frame) on the Assign screen with **TRACK 1**.

3. Use the **JOG/DATA** dial or the **SOURCE** button for **INPUT H** to set the recording source of **TRACK 1** to **H**.

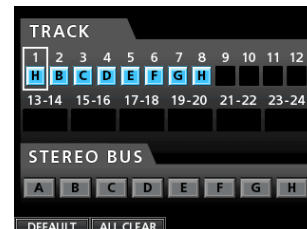

## Adjusting and monitoring the input level

1. Press the **HOME** button to return to the Home screen.

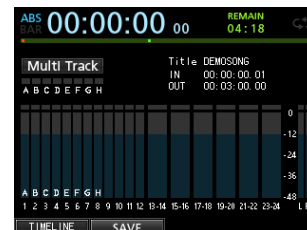

2. Press the **REC** button for **TRACK 1**.

The **REC** button flashes and the unit enters recording standby.

## 2 - Quick Guide

3. Use the **TRIM** knob for **INPUT H** to adjust the guitar input level. Set the **TRIM** knob so that the **OL** indicator for **INPUT H** does not light even when the loudest sound to be recorded is input.

If the **OL** indicator continues to light even when the **TRIM** knob is turned down, the guitar signal itself is too loud. In this case, lower the output level on the guitar.

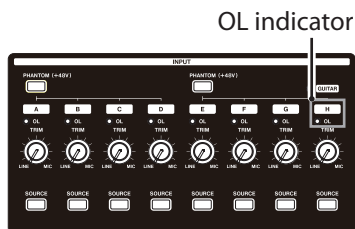

When you play the guitar, the input level is shown by the level meter for **1** (TRACK 1) on the display.

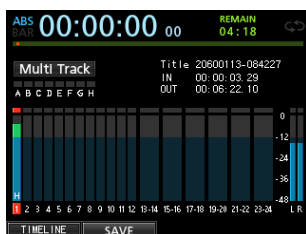

When you raise the fader for **TRACK 1**, the **STEREO** fader and the **MONITOR LEVEL** knob, you can hear the sound of the guitar through the headphones, and the **L** and **R** level meters move.

### NOTE

- You can use the **PAN** knob for **TRACK 1** on the Mixer screen to set the stereo position for monitoring.
- When the **REC** button for **TRACK 1** is unlit, you cannot hear the guitar sound that is being input.

## Recording a guitar to TRACK 1

1. Press the **RECORD** (●) button to start recording and play the guitar.

The **REC** button for **TRACK 1** stops flashing and lights steadily.

2. After you finish your performance, press the **STOP** (■) button to stop recording.

The recorded file is saved in the folder of the currently loaded song.

3. Press the **REC** button for **TRACK 1** so the **REC** button becomes unlit.

## Playing back the recording

1. To return to the beginning of the song (**ZERO** point), press and hold the **STOP** (■) button and press the **REW** (◀) (**TO ZERO**) button (**TO ZERO** function).
2. Press the **PLAY** (▶) button to play back the recording on **TRACK 1**.
3. Use the fader for **TRACK 1** and the **STEREO** fader to adjust the playback monitoring level. Use the **MONITOR LEVEL** knob to adjust the final monitoring volume.

### TIP

Use the **PAN** knob for **TRACK 1** on the Mixer screen to set the stereo position of the track signal.

## Recording a guitar to TRACK 2

Now you should listen to the rhythm guitar on **TRACK 1** and play the lead guitar on **TRACK 2**.

Follow the procedure below to change the recording source of the **TRACK 2**.

1. Press the **ASSIGN** button to open the Assign screen.

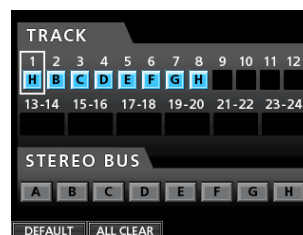

Record the lead guitar sound from **INPUT H** to **TRACK 2**. By default, **INPUT B** is assigned to **TRACK 2**.

2. Use the **CURSOR** (▲/▼/◀/▶) buttons or press the **SELECT** button for **TRACK 2** and align the cursor (frame) on the Assign screen with **TRACK 2**.

Use the **JOG/DATA** dial or press the **SOURCE** button for **INPUT H** to set the recording source of the **TRACK 2** to **H**.

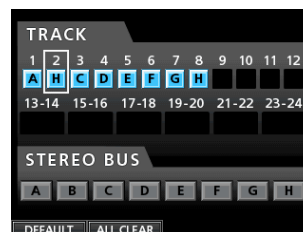

- Press the HOME button to return to the Home screen.

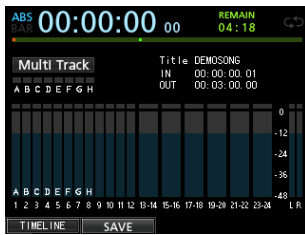

- Press the REC button for TRACK 2.

Its REC indicator blinks and the unit enters record standby.

When you play the guitar, the input level is shown by the level meter for 2 (TRACK 2).

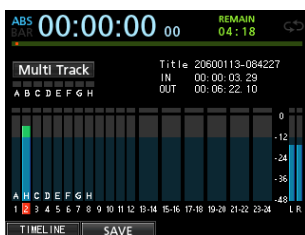

- Return to the beginning of the song (ZERO point) and start playback of the recorded rhythm guitar to play the lead guitar part along with the recording.

Raise the fader for TRACK 2 to hear both the playback of TRACK 1 and input guitar signal through your headphones.

- As necessary, use the faders for TRACK 1 and 2, PAN knobs, STEREO fader and MONITOR LEVEL knob to adjust the monitoring level and balance.

- Return to the beginning of the song, press the RECORD (●) button to start recording, and play the lead guitar part.

The RECORD (●) button lights red, and the REC indicator for TRACK 2 stops flashing and becomes lit.

- After you finish your performance, press the STOP (■) button to stop recording.

The recorded file is saved in the folder of the currently loaded song.

- Press the REC button for TRACK 2 so the REC button becomes unlit.

## Recording a vocal to TRACK 3

- Press the ASSIGN button to open the Assign screen.

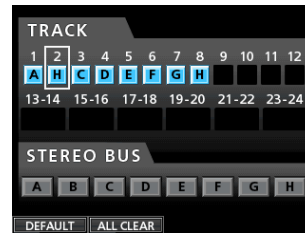

- Use the CURSOR (▲/▼/◀/▶) buttons or press the SELECT button for TRACK 3 and align the cursor (frame) on the Assign screen with TRACK 3.

Use the JOG/DATA dial or press the SOURCE button for INPUT B to set the recording source of the TRACK 3 to B.

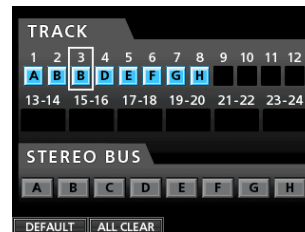

- Press the HOME button to return to the Home screen.

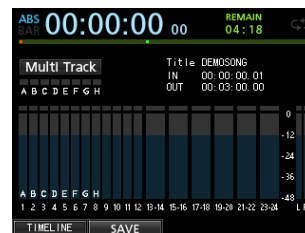

- Press the REC button for TRACK 3.

The REC indicator blinks and the unit enters record standby.

- Use the TRIM knob for INPUT B to adjust the input level suitably for the mic. Set the TRIM knob so that the OL indicator for INPUT B does not light even when the loudest sound to be recorded is input.

OL indicator

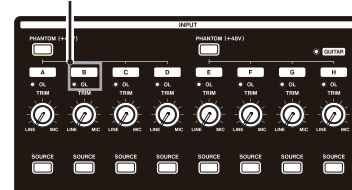



## 2 - Quick Guide

When you input a sound through an external microphone, the input level is shown by the  level meter.

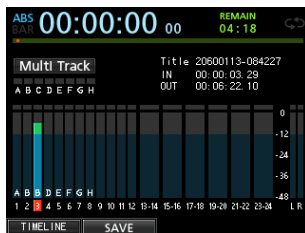

When you raise the fader for TRACK 3, the **STEREO** fader and the **MONITOR LEVEL** knob, you can hear the sound of the mic input through the headphones.

### NOTE

If the **OL** indicator continues to light even when the **TRIM** knob is turned down, the mic signal itself is too loud. In this case, move the mic further away from the sound source or lower the volume of the sound source.

### 6. Return to the beginning of the song, start playback of the recorded rhythm guitar and lead guitar parts, and sing along with the recording.

You can hear the playback of the recorded guitar parts on tracks 1 and 2 along with the vocal on your headphones.

### 7. As necessary, use the faders for TRACK 1 and 2, PAN knobs, STEREO fader and MONITOR LEVEL knob to adjust the monitoring level and balance.

### 8. Return to the beginning of the song, press the RECORD (●) button to start recording, and then sing along with the recording.

The **RECORD (●)** button lights red, and the **REC** indicator for TRACK 3 stops flashing and lights steadily.

### 9. After you finish your performance, press the STOP (■) button to stop recording.

The recorded file is saved in the folder of the currently loaded song.

### 10. Press the REC button for TRACK 3 so that the REC button becomes unlit.

## Mixing the tracks

Once you have finished your recording, you are ready to mix down and create a master file.

### 1. Use the faders for TRACK 1 to 3 to adjust their balance of levels. Use the STEREO fader to adjust the overall level.

### 2. Press the MIXER button to open the Mixer screen.

Press the **SELECT** buttons for TRACK 1 to 3 to select the track to be set and then use the **PAN** knob to set its stereo position.



### 3. Set the IN point.

The interval from the IN point to the OUT point will be used for the master file.

Play back the song, press and hold the **MARK SET** button and press the **IN** button at the point where you want to start the master file.

The position where you pressed the button is set as the IN point, which is where the mix down will start.

### 4. Set the OUT point.

Play back the song, press and hold the **MARK SET** button and press the **OUT** button where you want to end the master file.

The position where you pressed the button is set as the OUT point, which is where the mix down will end.

### TIP

You can also press and hold the **MARK SET** button and press the **IN** or **OUT** button to set the IN and OUT points when playback is stopped.

### 5. Press the MIXDOWN/MASTERING button.

The Recorder mode switches to **Mixdown** mode and the display returns to the Home screen.

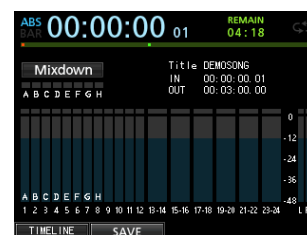

### NOTE

In Mixdown mode, **Mixdown** appears on the upper left corner of the Home screen.

### 6. Press the RECORD (●) button.

The master file recording starts.

Recording stops automatically when the OUT point is reached.



## NOTE

- The IN and OUT points must be at least 4 seconds apart. If the interval is shorter than 4 seconds, the message I/O Too Short will appear and the Recorder mode cannot switch to Mixdown mode.
- During recording, you can use the track faders to adjust the levels of the tracks and the overall level.
- You can also use the equalizer or reverb effect while recording a master file. (See "TRACK EQ (equalizer)" on page 68 and "Send effects" on page 69.)
- You can mute unwanted tracks so that they are not recorded to the master file. (See "Muting tracks" on page 48.)

## Mastering a recording

You can adjust the master file to tailor the sound to your preference. This process is called mastering.

### ■ Checking the master file

1. When Recorder mode is Mixdown mode, press the MIXDOWN/MASTERING button to open the MASTERING screen.

The Recorder mode switches to Mastering mode and the display returns to the Home screen.



## NOTE

- In Mastering mode, Mastering appears on the upper left corner of the Home screen.
  - When a master file does not exist, the Recorder mode cannot switch to Mastering mode.
  - If Recorder mode is Multi Track mode, you can press the MIXDOWN/MASTERING button to switch to the Mixdown mode, and then press the MIXDOWN/MASTERING button again to switch to the Mastering mode.
2. In this mode, press the PLAY (▶) button to listen to the master file that you have created.

## NOTE

- Confirm that both the EQ and COMP items are set to OFF. If either is set to ON, the sound heard will be affected by the equalizer and/or compressor. (See "Using the mastering EQ (equalizer)" on page 71 and "Using mastering compression" on page 72.)
- In Mastering mode, the STEREO fader cannot be used to adjust the level.

### ■ Applying equalization

In this example, we will use the equalizer on the master file to reduce high frequencies and increase low frequencies slightly.

1. When Recorder mode is Mastering mode, press the F1 (EQ) button to open the EQUALIZER screen.

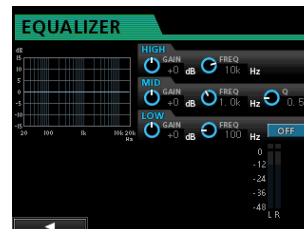

2. Turn the EQ HIGH knob to the left to lower the GAIN knob for HIGH shown on the screen. Set to "-2dB". This reduces the high frequencies.
3. Next turn the EQ MID knob to the left to lower the GAIN for MID. Set to "-2dB". This reduces the mid frequencies.
4. Next, turn the EQ LOW knob to the right to raise the GAIN knob for LOW shown on the screen. Set to "+6dB". This increase the low frequencies.
5. Press the ON/OFF button on the right of the LOW knob to turn the equalizer on.

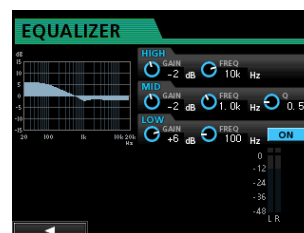

6. Press the F1 (◀) button to return to the Mastering screen.
7. Now you can press the PLAY (▶) button to listen to the master file with equalization.

### ■ Applying compression

Use the compressor on the master file to adjust the impact of the entire song.

1. When Recorder mode is Mastering mode, press the F2 (COMP) button to open the COMP MULTI screen.



## 2 - Quick Guide

2. Press the **F3 (LIBRARY)** button to open the library list.

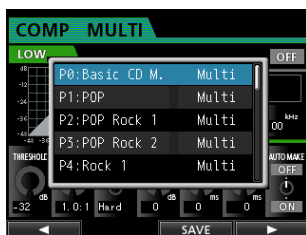

3. Use the **JOG/DATA** dial to select (blue highlight) an item from the list and then press the **F4 (▶)** button to load the appropriate setting from the library.

Load the appropriate setting from the library.

COMP MULTI is displayed.

### TIP

On the COMP MULTI screen, you can also change the parameters.

4. Press the **F4 (ON)** button to turn the compressor on. The indication OFF changes to ON.



5. Press the **F1 (◀)** button to return to the Mastering screen.
6. Press the **PLAY (▶)** button on the Mastering screen to listen to the master file with compression.

### NOTE

If the EQ item is set to ON on the EQUALIZER screen, the effect of the equalizer on the sound will also be heard.

### ■ Using normalizing

Normalizing maximizes the volume of the master file.

1. When Recorder mode is Mastering mode, press the **F4 (NORM)** button to open the NORMALIZE screen.

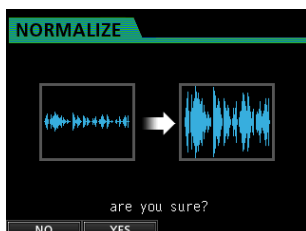

2. Press the **F2 (YES)** button to perform the normalization.
3. Once the process is completed, the display returns to the Mastering screen.

### ■ Using the noise shaper

You can use this function to reduce the quantization distortion.

1. When Recorder mode is Mastering mode, press the **F3 (NSD)** button to open the NOISE SHAPED DITHERING screen.

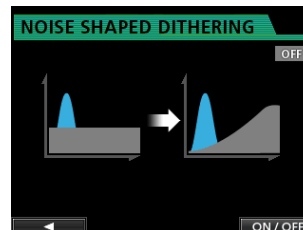

2. Press the **F4 (ON/OFF)** button to set the noise shaper to ON.
3. Press the **F1 (◀)** button to return to the Mastering screen.

### ■ Re-recording the master file

Re-record the master file with equalization and compression applied to create a new master file.

1. When Recorder mode is Mastering mode, press the **RECORD (●)** button.
2. This will record over the master file and create a new master file with equalization and compression applied.

### Creating an audio CD with the master file

You can use a master file that you have created to create an audio CD that can be played on an ordinary CD player, for example.

#### Inserting a CD

1. When Recorder mode is Multi Track mode, press the CD button to open the CD menu screen.



#### CAUTION

- When Recorder mode is a mode other than Multi Track mode, you cannot open the CD menu screen. In Mixdown or Mastering mode, press the **MIXDOWN/MASTERING** button repeatedly until you return to Multi Track mode. In Bounce mode, press the **BOUNCE** button to switch to the Multi Track mode.
- The disc tray will not open when the Home screen or MENU screen is displayed. Open the disc tray when the CD menu screen or CD PLAYER screen is shown.

2. Press the F3 (▲) button or the disc tray eject button on the front panel to open the tray slightly.

Pull the tray out until it opens completely as shown below.

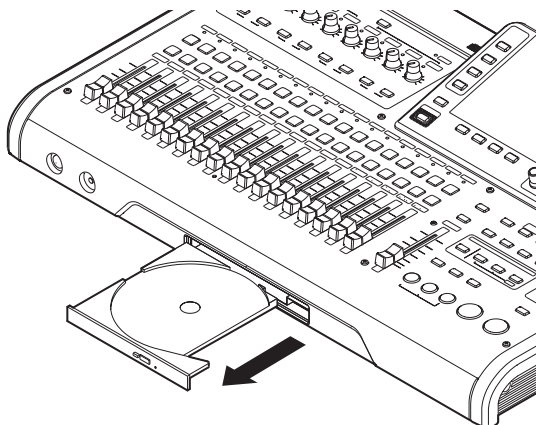

3. Hold the edge of the disc with the label side up and put it into the tray so that its central hole is on the round protrusion in the center of the tray, and then press the disc gently near the center to mount it on the tray.

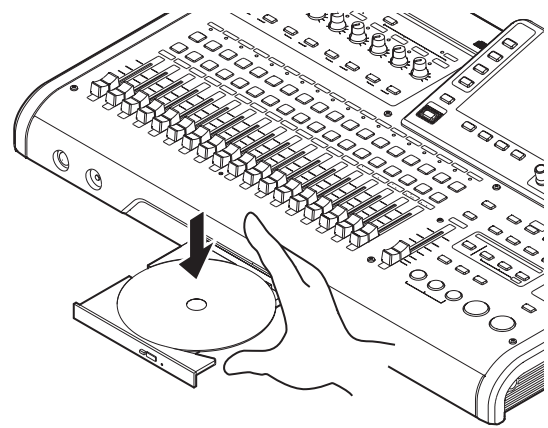

#### NOTE

The disc will click into place and be level with the tray.

4. Push the tray to close it. The tray will click when shut.

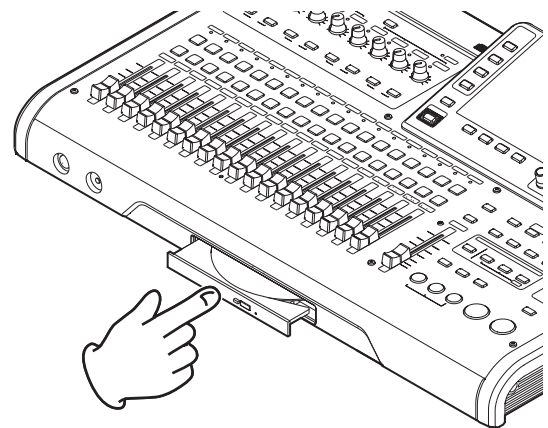

## 2 - Quick Guide

### Writing to a CD-R/CD-RW

When writing to a CD-R/CD-RW, the procedure differs between when you are choosing multiple master files and when you are choosing only one file.

In this example, we will select multiple master files to create a CD that can be played in ordinary CD players.

For details about writing to a CD-R/CD-RW, see "Creating an Audio CD" on page 87.

1. When Recorder mode is Multi Track mode, press the CD button to open the CD menu screen.
2. Place a blank CD (unused CD-R/CD-RW disc or a completely erased CD-RW) on the disc tray.
3. Use the JOG/DATA to select MASTER WRITE and then press the F4 (▶) button.

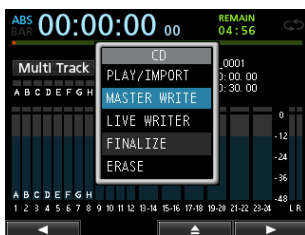

This opens the MASTER WRITE screen and shows a list of songs that have been recorded in master files.

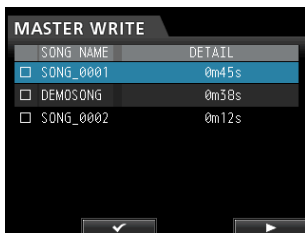

4. Use the JOG/DATA dial to select (blue highlight) a song that you want to write to the CD-R/CD-RW, and then press the F2 (✓) button.

A check mark ✓ appears in the check box next to the song.

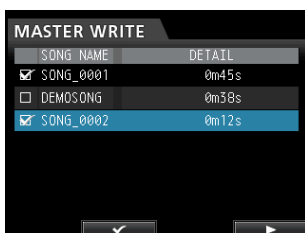

#### NOTE

To remove the check mark ✓ from a check box, press the F2 (✓) button again while the song with ✓ is selected (blue highlight).

5. Repeat step 4 above as necessary.
6. When you select all songs to be written, press the F4 (▶) button. The WRITE SONG LIST screen appears.

On this screen, you can change the order that the master files will be written to the CD-R/CD-RW and set the gaps between them. (For details about changing the order and setting the gaps, see "Creating an Audio CD" on page 87).

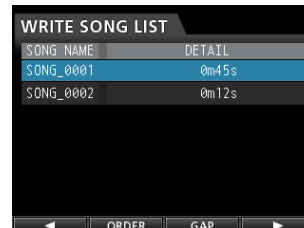

7. Press the F4 (▶) button again and a confirmation pop-up window will appear.

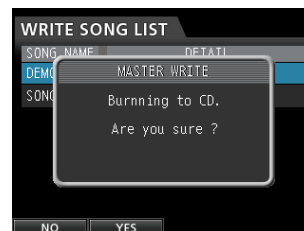

8. Press the F2 (YES) button to begin writing to the CD-R/CD-RW.
9. When writing is completed, a message asking whether you want to write another CD-R/CD-RW with the same contents appears.

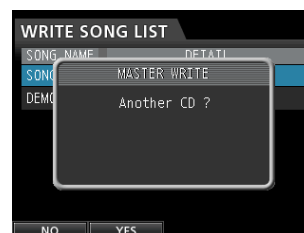

If you want to write the same contents to another CD-R/CD-RW, press the F2 (YES) button.

To finish the procedure, press the F1 (NO) button.

### Ejecting a CD

1. When Recorder mode is Multi Track mode, press the CD button to open the CD menu screen.

#### CAUTION

The disc tray will not open when the Home screen or MENU screen is shown. Open the disc tray when the CD menu screen or CD PLAYER screen is shown.

2. Press the F3 (▲) button or the disc tray eject button on the front panel to open the tray slightly, and then pull the tray out until it opens completely.

Hold the disc by its edges and lift it out.

#### CAUTION

Do not lift the disc forcibly. Doing so could damage the unit or the disc.

### Shutting down

Turn the unit off when you are done using it.

1. Press the HOME button to open the Home screen.

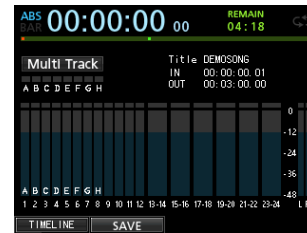

2. Press and hold the STANDBY/ON button on the rear panel until PORTASTUDIO appears on the display.



When the unit completes its automatic shutdown procedure, which includes recording various information about the operations that have been performed until now, the power turns off (standby).

Always use the procedure above to turn the power off properly.

#### CAUTION

When the power is on, do not cut the power to the unit by, for example disconnecting the power cord. All settings made since the last time you saved will not be saved. If you cut the power while an SD card is being accessed, all recorded songs and data may be damaged and cannot be recovered.

# 3 – Names and Functions of Parts

## Top panel

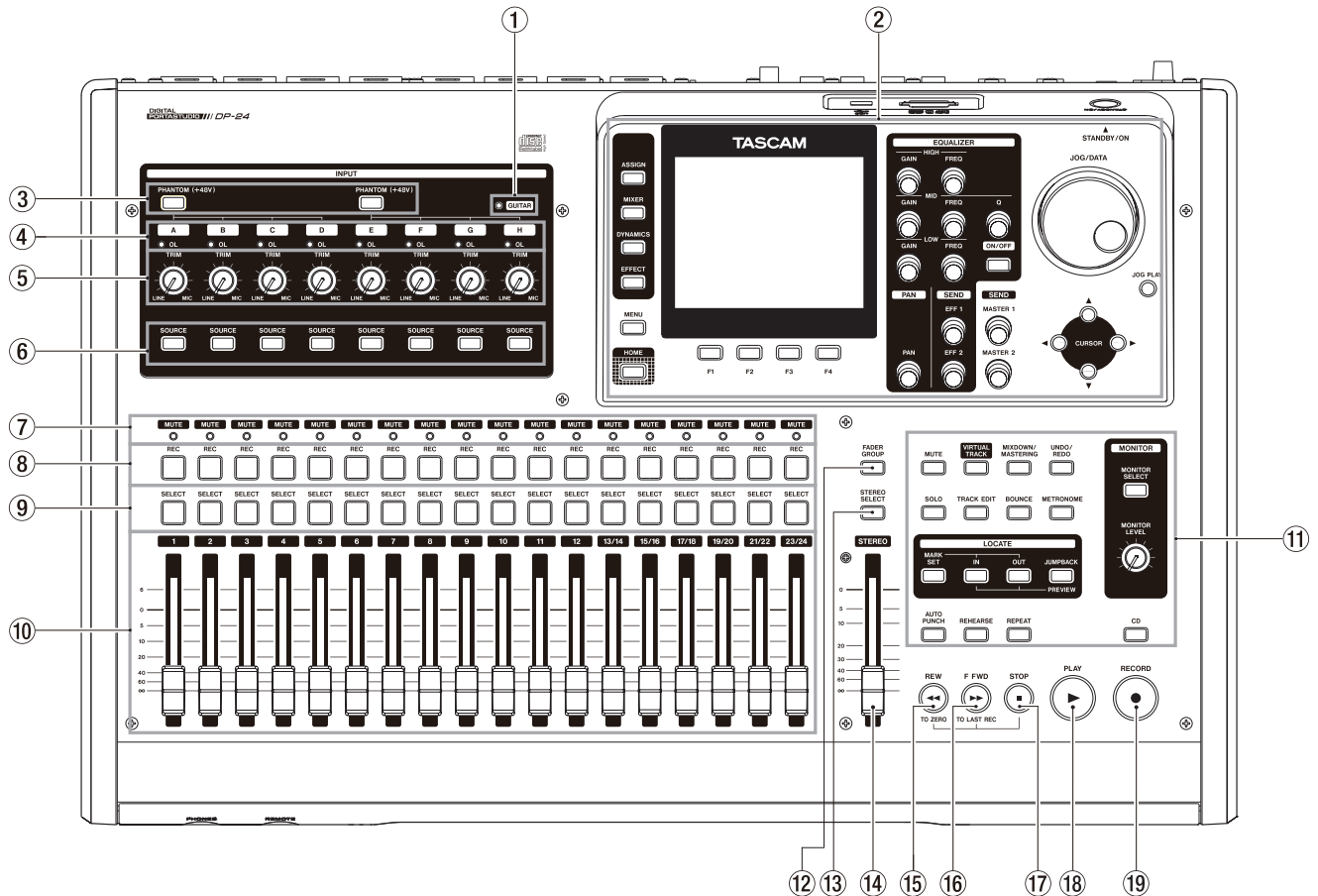

### ① GUITAR indicator

This indicator lights when the **LINE-GUITAR** switch on the rear panel is set to **GUITAR**.

### ② Display

Use the **JOG/DATA** dial or the **CURSOR** (▲/▼/◀/▶) buttons to return to the Home screen, to open the **MENU** screen, to assign input signals to tracks, to change parameters for each input or track, and to perform many other operations.

### ③ PHANTOM (+48V) button/indicator

Use this button to turn the phantom power on/off for the **MIC/LINE INPUT A-D** and **E-H** jacks on the rear panel.

The **PHANTOM** indicator lights when phantom power is turned on.

When the **GUITAR** indicator is lit, even if phantom (+48V) power is **ON** (indicator lit) for **E-H**, INPUT **H** will not receive phantom power.

### CAUTION

- Use the **STEREO** fader to lower the output volume of the unit before turning phantom power on or off. Depending on the microphone, a loud noise could occur, damaging equipment and harming people's hearing.
- Do not connect or disconnect a microphone when phantom power is turned on.

- Turn phantom power on only when using a condenser microphone that requires phantom power.
- Do not supply phantom power to an unbalanced dynamic microphone.
- Supplying phantom power to some types of ribbon microphones could break them. Do not supply phantom power to a ribbon microphone if you are in doubt.

### ④ OL indicators (A-H)

These indicators light when the input source signal is too loud.

### ⑤ TRIM knobs (A-H)

Use these knobs to adjust the input levels. (See "Making the first recording" on page 49.)

### ⑥ SOURCE buttons/indicators

When you press one of these buttons, the corresponding input (**INPUT A** to **H**) is selected (its button lights) as the input source.

The mixer and other functions are applied to the selected input.

These buttons are also used to assign an input source to a track (see "Assigning inputs" on page 44).

### ⑦ MUTE/SOLO indicators

These indicators light when a track is muted or in Solo mode. When the **SOLO** button is not lit, it indicates the



## 3 – Names and Functions of Parts

track is in Mute mode. When the SOLO button is lit, it indicates the track is in Solo mode.

### ⑧ REC buttons/indicators

Use these buttons to turn recording on/off for each track.

To monitor a track's input sound through headphones or a monitoring system, press the **REC** button for the corresponding track.

When the **REC** button is turned on, the **REC** button flashes when the recorder is stopped, and lights during recording.

### ⑨ SELECT buttons/indicators

When you press one of these buttons, the corresponding track (1 to 23/24) is selected (its button lights) as the current channel.

The mixer and other functions are applied to the current channel.

These buttons are also used for the following purposes.

- To assign an input source to a track (See "Assigning inputs" on page 44.)
- To assign effects to an input (See "Inserting a guitar effect" on page 64.)
- To select the group for FADER GROUP

### ⑩ TRACK faders (TRACK 1 to TRACK 23/24)

Use these faders to adjust the monitoring level of a track's playback signal or the input signal assigned to the track. (See "Levels and balance" on page 68.)

### ⑪ Operation buttons for various functions

Use these buttons to activate/deactivate functions or to perform the operation set to them.

### ⑫ FADER GROUP button/indicator

Press this button to set a fader group.

The button becomes lit.

### ⑬ STEREO SELECT button/indicator

When the Assign screen is displayed, you can press this button to move the cursor from the TRACK display to the STEREO BUS display, and set the input for the stereo bus.

### ⑭ STEREO fader

Use this fader to adjust the stereo signal level output from the **STEREO OUT** jacks and **PHONES** jack. Use this fader also to adjust the recording level when bouncing or mixing down tracks.

### ⑮ REW (◀◀) (TO ZERO) button

When stopped or during playback, press and hold this button to rewind. Rewind is performed at a fixed 10x speed.

Press briefly to jump to the previous mark.

Press and hold the **STOP (■)** button and press this button to locate the beginning of the song (00:00:00:00 = ZERO point). (See "Returning to zero (TO ZERO) and returning to last recording position (TO LAST REC)" on page 55.)

### ⑯ F FWD (▶▶) (TO LAST REC) button

When stopped or during playback, press and hold this button to fast-forward. Fast-forward is performed at a fixed 10x speed.

Press briefly to jump to the next mark.

Press and hold the **STOP (■)** button and press this button to locate the last recording position (LAST REC point). (See "Returning to zero (TO ZERO) and returning to last recording position (TO LAST REC)" on page 55.)

### ⑰ STOP (■) button

Use this button to stop playback, recording and fast-forward/rewind. Press at the same time as you press the **REW (◀◀) (TO ZERO)** button or **F FWD (▶▶) (TO LAST REC)** button to locate the beginning of the song (00:00:00:00 = ZERO point) or the last recording position (LAST REC point). (See "Returning to zero (TO ZERO) and returning to last recording position (TO LAST REC)" on page 55.)

### ⑱ PLAY (▶) button/indicator

Press this button to start playback.

During recording, press this button to stop recording and start playback (punch out).

During playback or recording, the **PLAY (▶)** button becomes lit.

### ⑲ RECORD (●) button/indicator

Press this button to start recording.

This button becomes lit during recording. During playback, if you press this button when a track **REC** button is flashing, recording to that track will begin (punch in). (See "Auto punch in/out" on page 57.)



## 3 – Names and Functions of Parts

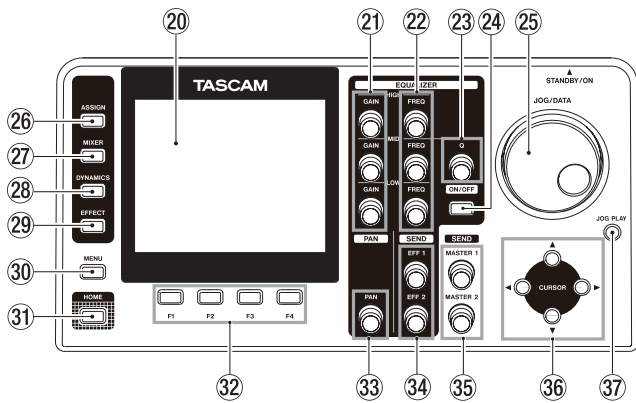

### 20 Color display

3.5-inch TFT LCD display with a resolution of 320x240 dots.

This display shows various types of information.

#### NOTE

The display is produced with extremely high-precision manufacturing technologies. More than 99.99% of the pixels operate to specification. Less than 0.01% of the pixels may occasionally misfire or appear as red or black dots.

This does not constitute a malfunction.

### 21 GAIN (HIGH/MID/LOW) knobs

Use these knobs to adjust the equalizer gain.

### 22 FREQ (HIGH/MID/LOW) knobs

Use these knobs to adjust the center frequency of the equalizer.

### 23 Q knob

Use this knob to adjust the MID bandwidth of the equalizer.

### 24 EQUALIZER ON/OFF button

Use this button to turn the equalizer on and off.

### 25 JOG/DATA dial

When the Home screen is displayed, you can use this dial to perform transport jog operations. (See "Jog positioning" on page 55.)

Use this dial to change parameter values and select items when using menus.

### 26 ASSIGN button/indicator

Use this button to set (assign) the input (INPUT A to H) for each track. When you press this button, the Assign screen is displayed. The input signal of the assigned input source becomes the recording source. (See "Assigning inputs" on page 44.)

### 27 MIXER button/indicator

Press this button to open the Mixer screen.

On this screen, you can adjust the settings for the inputs (INPUT A to H) or tracks (including GROUP) that are selected.

### 28 DYNAMICS button/indicator

Pressing this button opens a screen to adjust the settings for the effects applied to the inputs (INPUT A to H).

### 29 EFFECT button/indicator

Pressing this button opens a screen to make adjustments in the effects.

### 30 MENU button

Press this button to open the MENU screen.

### 31 HOME button

Press this button to open the Home screen.

### 32 F1 to F4 (Function) buttons

The functions of these buttons depend on the screen currently displayed. The functions currently assigned to the F1 to F4 buttons are shown at the bottom of the screen.

### 33 PAN knob

Use this knob to adjust the stereo position of the track's playback signal or the input signal assigned to that track. (See "Stereo position (panning)" on page 68.)

### 34 SEND EFF 1/EFF 2 knobs

Use these knobs to adjust the output of the EFFECT SENDS jacks.

You can also use the SEND EFF 1 knob to adjust the internal effects.

### 35 SEND MASTER 1/MASTER 2 knobs

Use these knobs to adjust the output of the EFFECT SENDS jacks.

You can also use the SEND MASTER 1 knob to adjust the internal effects.

### 36 CURSOR (▲/▼/◀/▶) buttons

Use these buttons to move the cursor on the screen.

### 37 JOG PLAY button

Press this button to switch to the Search mode.

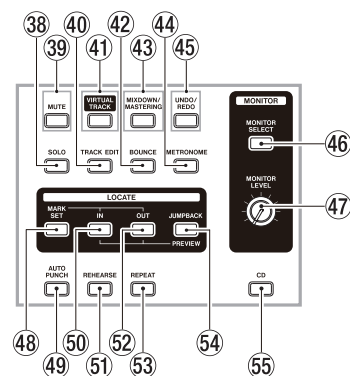

### 38 SOLO button/indicator

Press this button to switch to the Solo mode (the button lights). (See "Solo" on page 48.)

### 39 MUTE button/indicator

Press this button to switch to the Mute mode (the button lights). (See "Muting tracks" on page 48.)

### 40 TRACK EDIT button

Press this button to open the TRACK EDIT screen. (See "Track Editing" on page 60.)

## 3 – Names and Functions of Parts

### ④1 VIRTUAL TRACK button/indicator

The VIRTUAL TRACK screen appears. (See "Virtual tracks" on page 59.)

### ④2 BOUNCE button/indicator

Press this button to switch to the Bounce mode (the button lights).

### ④3 MIXDOWN/MASTERING button/indicator

Press this button to switch the Recorder mode among Multi Track, Mixdown and Mastering modes.

- In Multi Track mode, press this button to switch to the Mixdown mode.
- In Mixdown mode, press this button to switch to the Mastering mode when there is a master file, or press it to return to the Multi Track mode when there is no master file.
- In Mastering mode, press this button to return to the Multi Track mode.

#### NOTE

The current mode is displayed on the Home screen.

### ④4 METRONOME button/indicator

Press this button to set the metronome.

The button flashes according to the set tempo/beat.

### ④5 UNDO/REDO button/indicator

Press this button to undo the immediately previous action (single undo) or cancel a single undo (redo). (See "Undoing an operation" on page 50.)

After a single undo or multi-undo, the UNDO/REDO button becomes lit, showing that an operation has been undone.

### ④6 MONITOR SELECT button

Press this button to open the MONITOR SELECT pop-up window on the Home screen.

### ④7 MONITOR LEVEL knob

Use this knob to adjust the output level of the output signals.

### ④8 MARK SET button

During recording or playback, press this button to set a mark manually.

### ④9 AUTO PUNCH button/indicator

Press this button to turn the auto punch mode on and off.

When auto punch mode is turned on, Auto Punch is displayed on the Home screen. (See "Auto punch in/out" on page 57.)

### ⑤0 IN button

Press this button to locate the IN point.

Press and hold the MARK SET button and press this button to set the IN point.

Press and hold the JUMPBACK (PREVIEW) button and press this button to perform the pre-roll playback up to the current position and stop. (See "Checking cueing points (preview)" on page 57.)

### ⑤1 REHEARSE button/indicator

Use this button to turn the Rehearse mode on and off. In addition to auto punch in/out, you can also use the Rehearse mode for ordinary recording.

### ⑤2 OUT button

Press this button to locate the OUT point.

Press and hold the MARK SET button and press this button to set the OUT point.

Press and hold the JUMPBACK (PREVIEW) button and press this button to perform the post-roll playback from the current position, return and stop. (See "Checking cueing points (preview)" on page 57.)

### ⑤3 REPEAT button/indicator

Press to this button to turn Repeat Playback mode on and off. (See "Using repeat playback" on page 56.)

### ⑤4 JUMPBACK (PREVIEW) button

Press this button to rewind the specified number of seconds from the current position and start playback.

### ⑤5 CD button

Press this button to open CD menu screen.

## 3 – Names and Functions of Parts

### Front panel

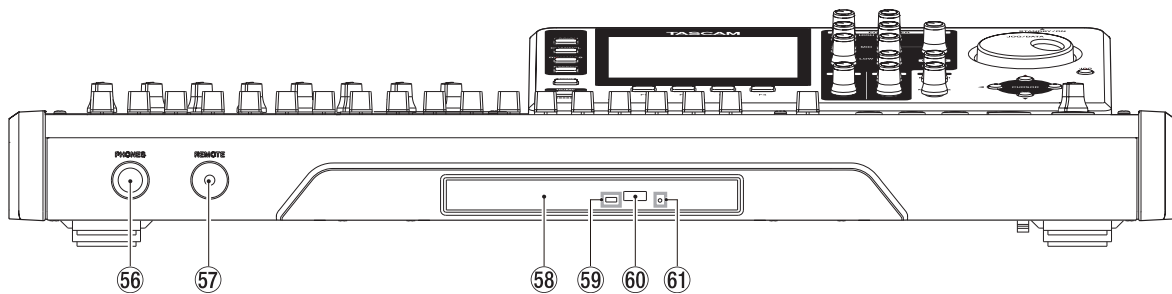

#### 56 PHONES jack

Use this stereo standard jack to connect stereo headphones.

Use the **MONITOR LEVEL** knob on the top panel to adjust the volume.

#### CAUTION

Before connecting headphones, use the **MONITOR LEVEL** knob on the top panel to set to the volume to minimum. A loud noise could occur, resulting in damages to equipment and people's hearing.

#### 57 REMOTE jack (2.5mm dia. TRS jack)

Connect the TASCAM RC-3F foot switch (sold separately). This allows you to remotely control a variety of operations, including punch in/out (start and stop recording).

#### 58 Disc tray

When the **CD** menu screen is displayed, press the **F3** (**▲**) button to open the disc tray and then load or remove a disc.

Push the tray to close it. The tray will click when shut.

#### 59 Access indicator

This indicator lights when the unit is accessing (reading or writing) a disc.

#### 60 Eject button

When the **CD** menu is displayed, press this button to open the disc tray.

#### 61 Emergency eject hole

If the disc tray does not open, press the button inside this hole to forcibly open the disc tray. (See "Forcing disc ejection" on page 86.)

#### CAUTION

Do not use this button at any time other than an emergency. Before doing this, turn the power off (standby) and disconnect the AC adapter.

### Rear panel

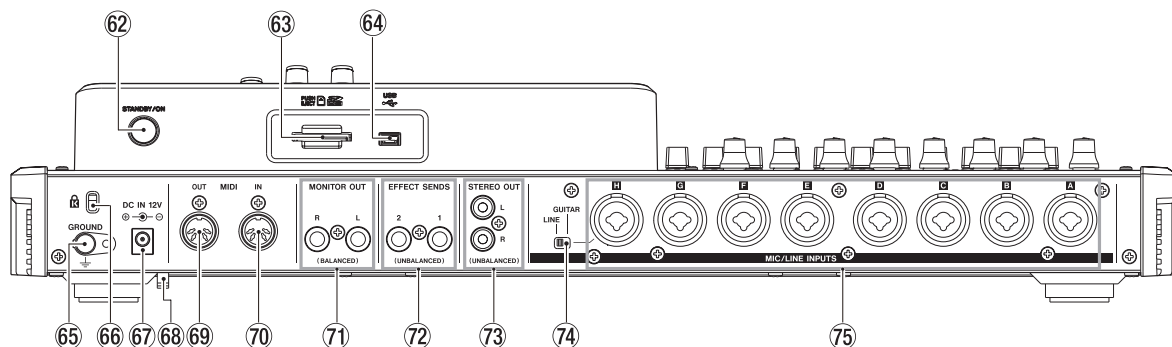

#### 62 STANDBY/ON button

When the power is OFF (standby), press and hold this button to turn the power on. When power is ON, press and hold this button to turn the power off (standby). (See "Start-up & Shutdown" on page 35.)

#### 63 SD card slot

Insert the SD card into this slot.

#### 64 USB port

Use the included USB cable to connect with a computer USB port. (See "Connecting to a computer" on page 80.)

#### CAUTION

Always connect the unit directly to a computer. Do not use a USB hub.

#### 65 GROUND connector

Depending on the use environment, you might hear noise when monitoring. If this occurs, use this connector to ground the unit. (Please prepare the necessary wiring yourself.)

#### 66 Kensington lock attachment hole

#### 67 DC IN 12V jack

Connect the supplied TASCAM PS-1225L AC adapter.

#### 68 Cord holder

Wrap the cord of the supplied TASCAM PS-1225L AC adapter around this holder to prevent the plug from becoming disconnected accidentally.

#### 69 MIDI OUT jack

This is a standard 5-pin DIN MIDI output jack.

This jack is used for MIDI signal output.

#### 70 MIDI IN jack

This is a standard 5-pin DIN MIDI input jack.

This jack is used for MIDI signal input.

#### 71 MONITOR OUT jacks (standard balanced TRS jacks)

These jacks output the signal selected in the monitor section of the top panel. These are standard balanced phone jacks.

#### 72 EFFECT SENDS jacks (standard unbalanced TS jacks)

These jacks output the signal from effect sends 1 and 2.

#### 73 STEREO OUT jacks (unbalanced RCA jacks)

These jacks output the stereo bus signal.

#### 74 LINE-GUITAR switch

You must set this switch according to the input source of the **MIC/LINE INPUTS H**. When connecting directly an electric guitar, electric bass or other similar instrument, set this switch to **GUITAR**.

When connecting a digital instrument or an audio equipment, set it to **LINE**.

#### 75 MIC/LINE INPUTS A-H jacks (balanced)

These are balanced analog XLR/TRS combo jacks for microphone and line inputs.

- XLR (1: GND, 2: HOT, 3: COLD)
- TRS (Tip: HOT, Ring: COLD, Sleeve: GND)

# 3 – Names and Functions of Parts

## Home screen

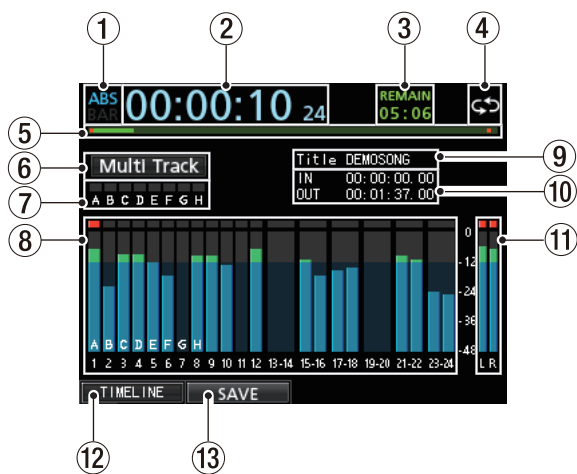

Home screen and track level meter display

**1 Counter mode display**

Displays the currently selected time counter mode: ABS or BAR.

**2 Recorder time counter display**

Displays the elapsed time from the start of the song.

**3 REMAIN time display**

Displays the remaining recordable time (Hours : Minutes) of the SD card.

**4 Repeat playback**

When the unit is in Repeat Playback mode, the icon is displayed.

**5 Playback position display**

Displays the current Playback position.

**6 Recorder mode display**

Displays the current Recorder mode.

Multi Track	Multi Track mode
Bounce	Bounce mode
Mixdown	Mixdown mode
Mastering	Mastering mode

The following items are also displayed: Rehearsal, Auto Punch and Search.

**7 INPUT A to H overload indicators**

If the input signal of any **INPUT A to H** source is too loud, the corresponding indicators light.

**8 Track level meter**

Displays input signal levels during recording and playback signal levels during playback.

**9 Song name display**

Displays the song name during playback.

**10 IN/OUT point time display**

Press and hold the **MARK SET** button and press the **IN** or **OUT** button to display the set IN or OUT point.

**11 Stereo level meter**

Displays the signal level output from the **STEREO OUT** jacks.

**12 TIMELINE/METER display**

When the level meter is displayed on the recorder track section of the Home screen, press the **F1 (TIMELINE)** button to change from level meter display to time line display.

When the time line is displayed on the recorder track section of the Home screen, press the **F1 (METER)** to change from time line display to level meter display.

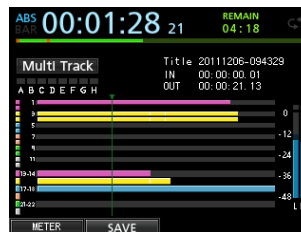

Timeline display on the Home screen

**13 SAVE display**

Press the **F2 (SAVE)** button to open the **SONG SAVE** (Saving a song) pop-up window.

## 3 – Names and Functions of Parts

### Menu structure

Press the **MENU** button to open the MENU screen.

The menu contains the following items.

Menu item	Function	Reference page
SONG	Performs song loading, saving and creation, and other song-related operations.	Page 38
AUDIO DEPOT	Performs import and export of WAV files.	Page 82
INFORMATION	Provides information about a song, file, and system.	Page 77
MIDI	Performs MIDI settings.	Page 74
TUNER	Performs the tuning of musical instruments.	Page 75
USB	Performs USB settings.	Page 80
FORMAT	Formats SD cards.	Page 78
PREFERENCE	Make settings for contrast, date and time, foot switch, jump back playback, Auto Monitor, and 76 etc.	Pages 35, 37, 52, 56 and 76

You can also use dedicated buttons to open specific setting screens.

The menu contains the following items.

Button	Function	Reference page
<b>ASSIGN</b>	Assigns track sources to INPUT A to H.	Page 44
<b>MIXER</b>	Displays the Mixer screen to make equalizer settings for tracks and inputs.	Pages 46 and 68
<b>DYNAMICS</b>	Assigns dynamic type effects such as compressor, etc., and makes parameters settings.	Page 64
<b>EFFECT</b>	Assigns each type of effect and makes parameter settings.	Page 64
<b>BOUNCE</b>	Performs track bouncing.	Page 53
<b>MIXDOWN/MASTERING</b>	Creates and adjusts master files.	Page 68
<b>METRONOME</b>	Sets the metronome.	Page 74

Press the **CD** button to open the CD menu screen.

The menu contains the following items.

Menu item	Function	Reference page
PLAY/IMPORT	Plays back an Audio CD. Imports songs from an Audio CD.	Pages 86 and 90
MASTER WRITE	Creates an Audio CD with the master file.	Page 87
LIVE WRITER	Creates an Audio CD of multiple tracks by dividing a master file with position marks.	Page 89
FINALIZE	Finalizes unfinalized CD-R/CD-RW discs.	Page 90
ERASE	Erases a written CD-RW disc.	Page 91

# 3 – Names and Functions of Parts

## Screen operations

Use the **MENU** button and dedicated buttons to open screens, and then follow the guidelines below to use the functions on the screens.

These examples show basic operation procedures, but the actual assignments of the function buttons (**F1** to **F4** buttons) vary depending on the screen.

- Use the **JOG/DATA** dial or the **CURSOR** (▲/▼/◀/▶) buttons to select (green highlight) the desired item.



This example shows the **MENU** screen.

The **SONG** menu item is selected on this screen.

**NOTE**

**About function buttons**

The assignments of the function buttons (**F1** to **F4**) are shown at the bottom of the screen above the buttons themselves.

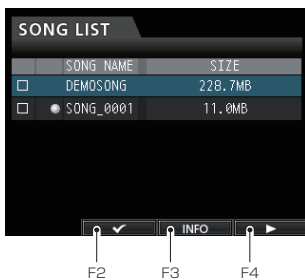

"✓" above the **F2** button shows that "✓" is assigned to the **F2** button when using this screen.

In this manual, the function assigned to a function button is described as **F2** (✓) button, for example.

In this way, "INFO" is assigned to the **F3** button, and "▶" is assigned to the **F4** button.

- When an item has a sub-menu, "▶" appears on its right side, and the **F4** (▶) button is used to open it.

- On the sub-menu, you can press the **F1** (◀) button to return to the previous screen.



This example shows the **LOAD** screen.

On the sub-menu, use the **JOG/DATA** dial or the **CURSOR** (▲/▼) buttons to select **LOAD**, and then press the **F4** (▶) button to load the song.

- When the cursor (blue highlight) is on a setting value, use the **JOG/DATA** dial to change the value.

To select an item, use the **CURSOR** (▲/▼) buttons.

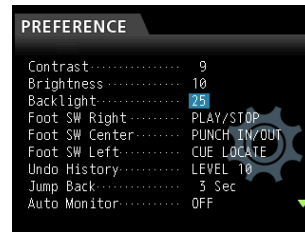

This example shows the **PREFERENCE** screen.

Use the **JOG/DATA** dial to change the value.

Move the cursor (blue highlight) up or down.

- When you have to move left or right, use the **CURSOR** (◀/▶) buttons.

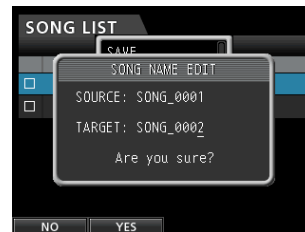

- Press the **HOME** button to return to the Home Screen.





# 4 – Preparation

## Inserting and removing SD cards

### Inserting an SD card

Insert the SD card into the SD card slot on the rear panel as shown in the illustration until it clicks into place.

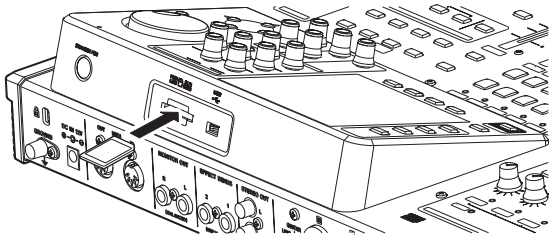

#### NOTE

An SD card is installed in the SD card slot when the unit is shipped from the factory. If you want to use this card to record and play tracks, there is no need to reinstall it.

### Removing the card

Push the loaded card in gently to eject it.

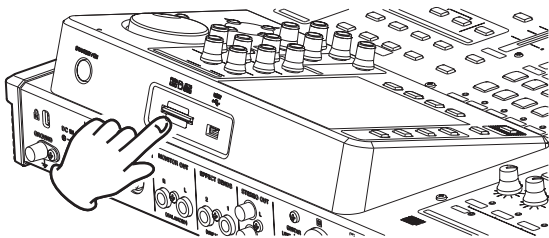

#### CAUTION

- Always turn the power off (standby) before removing an SD card.  
If you remove or insert an SD card when the power is on, recorded data may be lost and cannot be recovered.
- SD and SDHC cards that are at least 512 MB in size can be used.
- A list of SD cards that have been confirmed to work with this unit can be found on TASCAM website (<http://tascam.com/>).

## About write-protected SD cards

SD cards have write-protect (lock) switches.

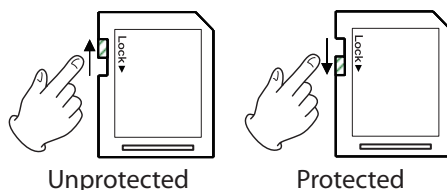

When the protect switch is in the LOCK position, files cannot be recorded or edited on the card. Slide the switch away from the LOCK position if you want to record, erase or otherwise change files on a card.

## Powering the unit

As shown in the illustration, connect the included TASCAM PS-1225L AC adapter to the **DC IN 12V** jack.

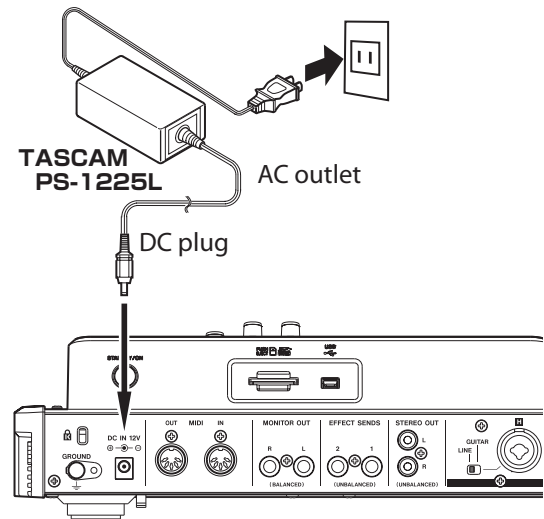

The bottom panel has a hook (cord holder) that can be used to hold the AC adapter cord in place. When using it, wrap the cord around this cord holder to prevent it from being disconnected during use.

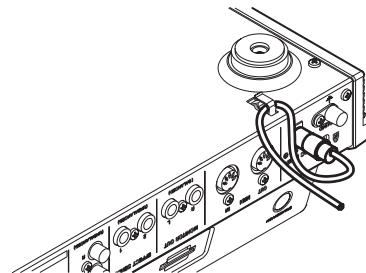

#### CAUTION

- Use only the included TASCAM PS-1225L AC adapter and power cord. Use of a different AC adapter could cause malfunction, fire or electric shock.
- Be sure to use the included TASCAM PS-1225L AC adapter to supply power to this unit. Power cannot be supplied to this unit via USB.

## Start-up & Shutdown

### CAUTION

- Turn down the volume of the sound monitoring system connected to the unit before starting up or shutting down the unit.
- Do not use headphones when starting up or shutting down the unit. Otherwise, a large noise would cause damage to headphones or your ears.

### Starting up the unit

Press and hold the **STANDBY/ON** button on the rear panel for a few seconds.

When the unit starts, the startup screen appears briefly followed by the Home screen.

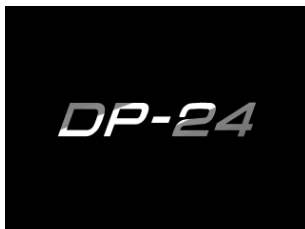

Start-up screen



Home screen

When the unit starts up, it defaults to Multi Track mode of the Recorder mode, regardless of the mode used last before shutting down.

### Shutting down

Make the following preparations before shutting down the unit.

- Stop the recorder. (The unit cannot be shut down during a recording and other procedures.)
- Return to the Home screen.
- If the unit is connected to a computer, disconnect the USB cable after performing the necessary procedure on the computer to disconnect the unit.

After making these preparations, press and hold the **STANDBY/ON** button on the rear panel until the following screen appears.



The power is turned off (standby) after the unit completes its shutdown process, including saving various information from your session.

### CAUTION

- When the power is on, do not cut the power to the unit by, for example disconnecting the power cord. All settings made since the last time you saved will not be saved. If you cut the power while an SD card is being accessed, all recorded songs and data may be damaged and cannot be recovered.

### NOTE

- When the power is turned off (standby), the currently loaded song is saved. When the power is turned on again, the last song used is reloaded in the same state it was when the power was turned off (standby). You can even undo and redo previous operations.

## Setting the date and time

Using its internal clock, this unit remembers the date and time when a song or file is recorded.

1. **When the recorder is stopped, press the MENU button to open the MENU screen.**
2. **Use the JOG/DATA dial or the CURSOR (▲/▼/◀/▶) buttons to select (green highlight) PREFERENCE, and then press the F4 (►) button.**  
The PREFERENCE screen appears.
3. **Use the CURSOR (▲/▼) buttons to select (blue highlight) Date/Time, and then press the F4 (►) button.**

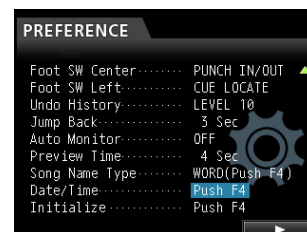

The DATE/TIME screen appears.

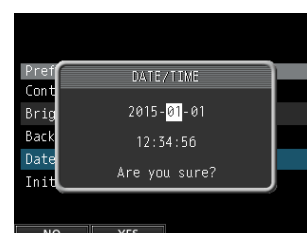

## 4 – Preparation

- Use the **CURSOR** (◀/▶) buttons to move the cursor (blue highlight) to the desired item, and then use the **JOG/DATA** dial to change the value.
- After making the settings, press the **F2 (YES)** button to return to the Home screen.

### NOTE

- The time indication stops while time is being set.
- You can automatically add the date you have set to file names by specifying **Song Name Type** on the **PREFERENCE** menu.

## Preparing an SD card for use

In order to use an SD card in this unit, you must format it first.

### CAUTION

The included SD card is already formatted, so formatting it is not necessary. Formatting the supplied SD card erases the demo song previously stored.

- Confirm that the SD card is loaded and turn the power on.
- A pop-up message "Invalid Card" appears when a new SD card or an SD card formatted for use with another device is installed in the unit.
- You can also reformat a card in this unit at any time. (See "Quick formatting an SD card" on page 78 and "Full formatting an SD card" on page 79.)

To clear the pop-up message, press the **F1** button.

## Recorder modes

This unit has four recorder modes.

### Multi Track

Use this mode to operate the unit as a multitrack recorder.

### Bounce

Use this mode to perform track bouncing. (See "Bouncing tracks" on page 53.)

### Mixdown

Use this mode to mix down tracks to create a master file. (See "Mixing down tracks" on page 68 and "Creating a master file" on page 69.)

### Mastering

Use this mode to play back the master files that you have created and apply effects and tailor them to suit your preferences (mastering). (See "Checking the master file" on page 70 and "Finishing up a master file (mastering)" on page 71.)

When the unit starts up, it defaults to **Multi Track** mode of the Recorder mode, regardless of the mode used last before shutting down.

When Recorder mode is any mode other than **Multi Track** mode, many of the usual operations using the screen are unavailable.

In this manual, the **Multi Track** mode is the Recorder mode explained unless otherwise noted.

## Connecting other equipment

This section shows examples of how to connect other devices to this unit.

### Precautions before making connections

- Turn off (standby) this unit and all devices that you will connect beforehand.
- Supply power to all the devices from the same line. When using a power strip, for example, use one with a cable that has a high electric current capacity in order to minimize power voltage variations.

### Front panel

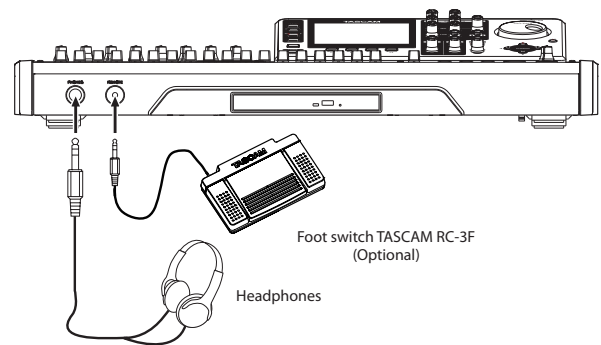

## Rear panel

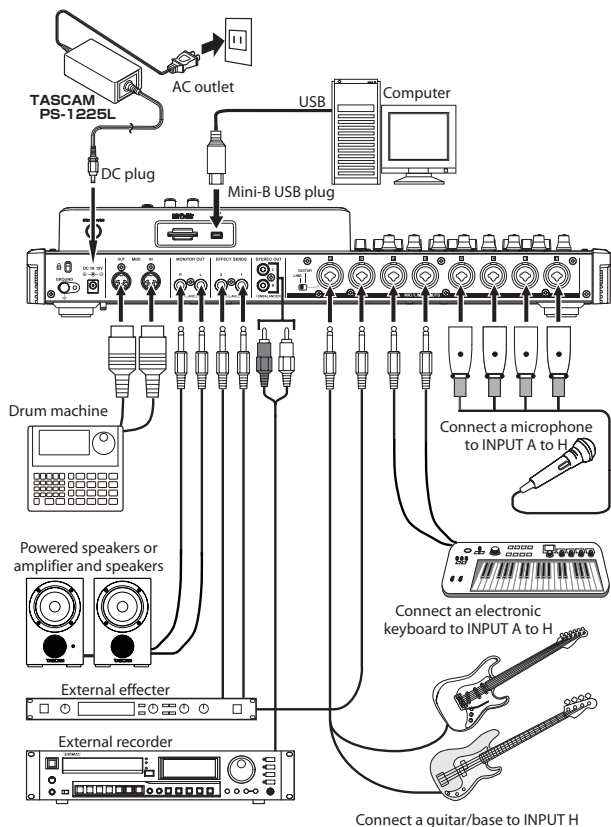

### CAUTION

- Do not connect a dynamic microphone using an unbalanced connection when phantom power is ON. Doing so could break it.
- Do not connect or disconnect a microphone when phantom power is ON. This could cause a loud noise and damage the equipment.
- Before turning the phantom power on or off, turn down the output volume using the **MONITOR LEVEL** knob, **STEREO** fader and external monitor monitoring system. Depending on the microphone, a loud noise could occur, resulting in damages to the equipment and people's hearing.

### NOTE

- Before producing any sound, minimize the output volume using the **MONITOR LEVEL** knob and external monitoring system. A loud noise could occur, resulting in damages to equipment and people's hearing.
- Recorder functions cannot be used when the unit is connected to a computer via USB.

### TIP

When connecting an electric-acoustic guitar with a built-in preamp or an active-type electric guitar, or when using an effects pedal, for example, between the guitar and this unit, set in the **LINE-GUITAR** switch on the rear panel to **LINE**.

## Adjusting the contrast

You can adjust the contrast of the display.

Follow the procedure below to adjust the contrast.

- When the recorder is stopped, press the **MENU** button to open the **MENU** screen.
- Use the **JOG/DATA** dial or the **CURSOR** (**▲/▼/◀/▶**) buttons to select (green highlight) **PREFERENCE**, and then press the **F4** (**▶**) button.

The **PREFERENCE** screen appears.

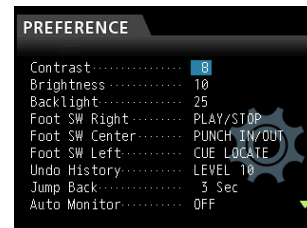

- Use the **CURSOR** (**▲/▼**) buttons to select the items you want to adjust such as **Contrast**, **Brightness** and **Back light**, and then use the **JOG/DATA** dial to make the adjustments.
- After making the settings, press the **HOME** button to return to the Home screen.

# 5 - Song Management

This unit manages data in units called "songs". Ordinarily, each project should have its own "song" file. The first step is to load the song that you want to manage (load an existing song or create a new song).

In a song, the audio data for the recorded multitrack (TRACK 1 to 24) and the master file are saved.

This chapter covers basic operations, including procedures for loading songs and creating new songs, as well as explains various song management functions.

## Editing names

You can edit names on the following screens.

**When creating, saving or editing the name of a song**

SONG CREATE pop-up window, SONG SAVE pop-up window, SONG NAME EDIT pop-up window, SONG COPY pop-up window

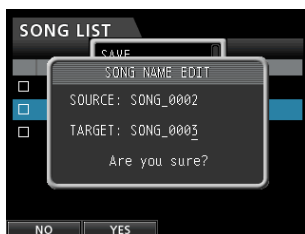

SONG NAME EDIT screen

Follow the procedure below to edit names.

- Use the **CURSOR** (◀/▶) buttons to move the cursor (underline). The character at the cursor position (underline) is the one that can be edited.
- Use the **JOG/DATA** dial to change the characters at the cursor (underline) position. You can input a maximum of 15 characters, including ordinary symbols, numerals and English upper and lowercase letters.
- After inputting or editing, press the **F2** (YES) button to save the edited name.

## Loading a song

Follow the procedure below to load the song you want.

1. **When the recorder is stopped, press the MENU button to open the MENU screen.**
2. **Use the JOG/DATA dial or the CURSOR (▲/▼/◀/▶) buttons to select (green highlight) SONG, and then press the F4 (▶) button.**

The SONG LIST screen appears.

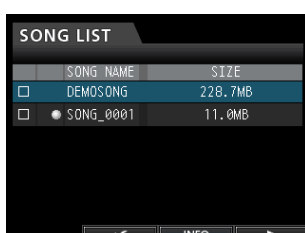

### NOTE

The ● icon appears next to the the currently loaded song.

A lock icon appears to the left of songs that are protected.

3. **Use the JOG/DATA dial or the CURSOR (▲/▼) buttons to select the desired song, and then press the F4 (▶) button to open the corresponding sub-menu.**

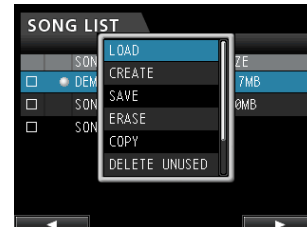

Use the **JOG/DATA** dial or the **CURSOR** (▲/▼) buttons to select **LOAD**, and then press the **F4** (▶) button again.

4. **The SONG LOAD pop-up window appears.**

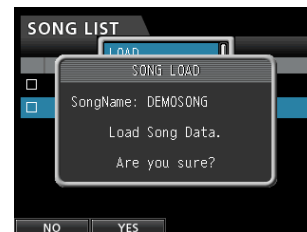

5. **Press the F2 (YES) button to load the selected song.**

### NOTE

If you press the **F1** (NO) button, the pop-up window disappears and the display returns to the SONG LIST screen.

6. **Once the song is loaded, the pop-up window disappears and the display returns to the SONG LIST screen.**
7. **Press the HOME button to return to the Home screen.**

## Creating a new song

Follow the procedure below to create a new song.

1. **When the recorder is stopped, press the MENU button to open the MENU screen.**
2. **Use the JOG/DATA dial or the CURSOR (▲/▼/◀/▶) buttons to select (green highlight) SONG, and then press the F4 (▶) button.**

The SONG LIST screen appears.

3. Press the **F4 (▶)** button to open the corresponding sub-menu.

Use the **JOG/DATA** dial or the **CURSOR (▲/▼)** buttons to select **CREATE** from the sub-menu, and then press the **F4 (▶)** button.



4. Press the **F4 (▶)** button to open the **SONG CREATE** pop-up window.

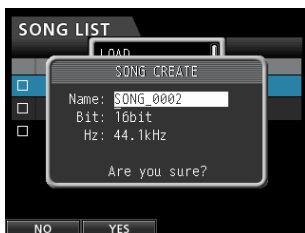

The created song is given the name depending on the setting of **Song9 Name Type** on the **PREFERENCE** menu.

5. Change the song name in the **Name** item if you want. (See "Editing names" on page 38.)

**TIP**

You can edit the name of a song later selecting **NAME EDIT** from the **SONG** screen. You can also edit the song name when saving the song.

6. Align the cursor with **Bit** and turn the **JOG/DATA** dial to set the bit rate. (Default: 16bit)
7. Align the cursor with **Hz** and turn the **JOG/DATA** dial to set the sampling frequency. (Default: 44.1kHz)

**CAUTION**

When creating a CD from a master file, set to 44.1kHz, 16bit.

8. Press the **F2 (YES)** button to save the currently loaded song and create a new song.

**NOTE**

If you press the **F1 (NO)** button, the pop-up window disappears and the display returns to the **SONG LIST** screen.

9. Once the song is created, the pop-up window disappears and the display returns to the **SONG LIST** screen.
10. Press the **HOME** button to return to the Home screen.

## Saving a song

This unit automatically saves the current song during shutdown and when loading another song. You can also save a song at any time using the procedure below.

1. When the recorder is stopped, press the **MENU** button to open the **MENU** screen.
2. Use the **JOG/DATA** dial or the **CURSOR (▲/▼/◀/▶)** buttons to select (green highlight) **SONG**, and then press the **F4 (▶)** button.

The **SONG LIST** screen appears.

3. Press the **F4 (▶)** button to open the corresponding sub-menu.

Use the **JOG/DATA** dial or the **CURSOR (▲/▼)** buttons to select **SAVE** from the sub-menu, and then press the **F4 (▶)** button.

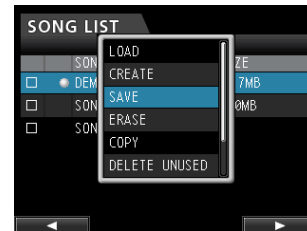

4. Press the **F4 (▶)** button to open the **SONG SAVE** pop-up window.

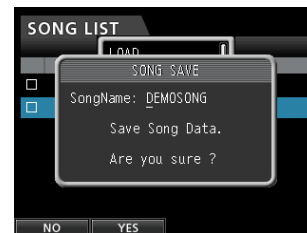

5. Change the song name in the **SongName** item if you want. (See "Editing names" on page 38.)

To save without changing the name, just press the **F2 (YES)** button.

6. Once the song is saved, the pop-up window disappears and the display returns to the **SONG LIST** screen.

7. Press the **HOME** button to return to the Home screen.

**TIP**

The **SAVE** item, which is one of the **SONG LIST** sub-menus, can also be selected through the **F2 (SAVE)** button on the Home screen.



# 5 - Song Management

## Viewing song information

You can check the song file format, song name (title), time/date, and song size.

1. Press the **MENU** button to open the **MENU** screen.
2. Use the **JOG/DATA** dial or the **CURSOR** (**▲/▼/◀/▶**) buttons to select (green highlight) **SONG**, and then press the **F4 (▶)** button.

The **SONG LIST** screen appears.

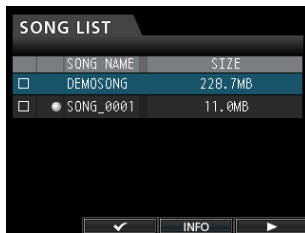

3. Press the **F3 (INFO)** button to show a song information which appears in the following order: **SIZE, SAMPLE RATE, SAMPLE BIT, and DATE.**

## Copying songs

You can copy songs.

1. When the recorder is stopped, press the **MENU** button to open the **MENU** screen.
2. Use the **JOG/DATA** dial or the **CURSOR** (**▲/▼/◀/▶**) buttons to select (green highlight) **SONG**, and then press the **F4 (▶)** button.

The **SONG LIST** screen appears.

3. Select (blue highlight) a song you want to copy.



4. Next, press the **F4 (▶)** button to open the corresponding sub-menu. Use the **JOG/DATA** dial or the **CURSOR** (**▲/▼**) buttons to select the item **COPY** from the sub-menu, and then press the **F4 (▶)** button.

A pop-up message appears asking you to confirm the copy.

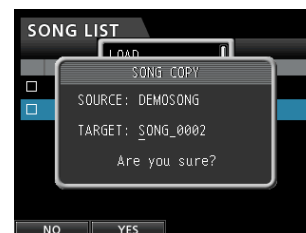

5. Change the song name as you want and press the **F2 (YES)** button.

### NOTE

To cancel the song copy operation, press the **F1 (NO)** button instead of the **F2 (YES)** button.

6. When the song copy operation is completed, the pop-up window disappears and the display returns to the **SONG LIST** screen.

## Erasing songs

You can erase songs. You can also erase multiple songs at once. You might want to erase unneeded songs if the SD card starts to run out of space.

1. When the recorder is stopped, press the MENU button to open the MENU screen.
2. Use the JOG/DATA dial or the CURSOR (▲/▼/◀/▶) buttons to select (green highlight) SONG, and then press the F4 (▶) button.

The SONG LIST screen appears.

3. Select (blue highlight) the song you want to erase and then press the F2 (✓) button. To erase multiple songs, select all songs you want to erase.

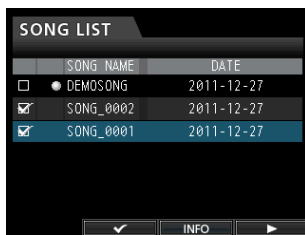

### NOTE

To remove the check mark ✓ from a check box, press the F2 (✓) button again while the song is selected (blue highlight).

4. Next, press the F4 (▶) button to open the corresponding sub-menu. Use the JOG/DATA dial or the CURSOR (▲/▼) buttons to select the item ERASE from the sub-menu, and then press the F4 (▶) button.

A pop-up message appears asking you to confirm the erase.

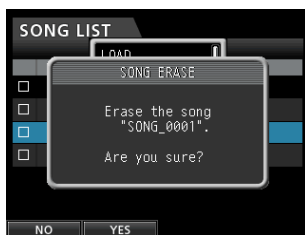

5. Press the F2 (YES) button to perform the erase.

### NOTE

To cancel the song erase operation, press the F1 (NO) button instead of the F2 (YES) button.

6. When the song erase operation is completed, the pop-up window disappears and the display returns to the SONG LIST screen.

### NOTE

The MUSIC folder must always have at least one song stored. Therefore, one song will be automatically created when you insert or format a card.

## Protecting songs

If you protect a song, editing, recording and erasing of that song is prevented.

1. When the recorder is stopped, press the MENU button to open the MENU screen.
2. Use the JOG/DATA dial or the CURSOR (▲/▼/◀/▶) buttons to select (green highlight) SONG, and then press the F4 (▶) button.

The SONG LIST screen appears.

3. Select the (blue highlight) song you want to protect and then press the F2 (✓) button. To protect multiple songs, select all songs you want to protect.



### NOTE

To remove the check mark ✓ from a check box, press the F2 (✓) button again while the song is selected (blue highlight).

4. Next, press the F4 (▶) button to open the corresponding sub-menu. Use the JOG/DATA dial or the CURSOR (▲/▼) buttons to select the PROTECT item from the sub-menu, and then press the F4 (▶) button.

The song protect function is enabled for the selected song.

5. When the song protect operation is completed, the pop-up window disappears and the display returns to the SONG LIST screen.

### NOTE

- In a song list used to copy, erase or perform other functions, a lock icon will appear next to protected songs.
- If you try to perform a prohibited operation (edit, record, erase) on a protected song, a Song Protected message will appear and the operation will be canceled.
- To remove the protection from a song, follow the same procedure above.

## 5 - Song Management

### Deleting unnecessary audio data from a song

In addition to audio data for a track, a song may also contain "unused" audio data.

When a track is overwritten in this unit, the overwritten audio data is not erased, but remains on the SD card. Audio data that has been completely overwritten is "unused" audio data.

You can delete such "unused" audio data by following the procedure below.

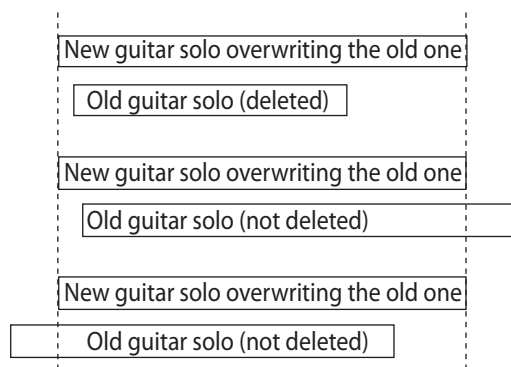

As shown in the illustration, if old audio data is not completely overwritten by new audio data, old audio data cannot be deleted.

"Unused" old audio data in any virtual track that has not been assigned to a physical track can also be deleted. (See "Virtual tracks" on page 59.)

Follow the procedure below to delete "unused" audio data and create room on the SD card for additional storage (this operation cannot be undone).

- 1. When the recorder is stopped, press the MENU button to open the MENU screen.**
- 2. Use the JOG/DATA dial or the CURSOR (▲/▼/◀/▶) buttons to select (green highlight) SONG, and then press the F4 (▶) button.**

The SONG LIST screen appears.

- 3. Select (blue highlight) the song which contains unnecessary audio data and then press the F2 (✓) button. To erase multiple songs, select all songs you want to erase.**

#### NOTE

To remove the check mark ✓ from a check box, press the F2 (✓) button again while the song is selected (blue highlight).

- 4. Next, press the F4 (▶) button to open the corresponding sub-menu. Use the JOG/DATA dial or the CURSOR (▲/▼) buttons to select the item DELETE UNUSED from the sub-menu, and then press the F4 (▶) button.**

A confirmation message appears.

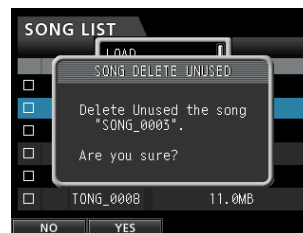

- 5. Press the F2 (YES) button.**

The unnecessary audio data is deleted from the song(s).

When the erase operation is completed, the pop-up window disappears and the display returns to the SONG LIST screen.

#### NOTE

To cancel the unused audio data erase operation, press the F1 (NO) button instead of the F2 (YES) button.

#### CAUTION

This operation deletes all unused audio data from the selected songs and cannot be undone. Therefore, if you think you use this audio data later, back up the data to a computer before executing the DELETE UNUSED item. (See "Connecting to a computer" on page 80.)

## Changing a song name

1. When the recorder is stopped, press the **MENU** button to open the **MENU** screen.
2. Use the **JOG/DATA** dial or the **CURSOR** (**▲/▼/◀/▶**) buttons to select (green highlight) **SONG**, and then press the **F4** (**▶**) button.

The **SONG LIST** screen appears.

3. Select (blue highlight) a song you want to change the name.



4. Next, press the **F4** (**▶**) button to open the corresponding sub-menu. Use the **JOG/DATA** dial or the **CURSOR** (**▲/▼**) buttons to select the item **NAME EDIT** from the sub-menu, and then press the **F4** (**▶**) button.

Now you can change the song name.

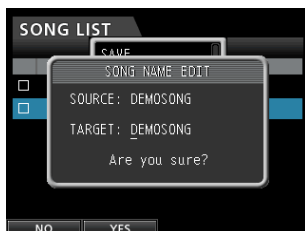

5. Change the song name as you want and press the **F2** (**YES**) button.

### NOTE

To cancel the song name change, press the **F1** (**NO**) button instead of the **F2** (**YES**) button.

6. Once the song name is changed, the pop-up window disappears and the display returns to the **SONG LIST** screen.

# 6 - Basic Recording

## Selecting the input sources

This unit is equipped with eight inputs (**INPUT A to H**), and each of them has a standard XLR/TRS combo jack.

In addition to mic and line signals, you can connect a guitar to the **INPUT H** standard jack. When connecting a guitar, set the **LINE-GUITAR** switch on the rear panel to **GUITAR**.

### TIP

When connecting an electric-acoustic guitar with a built-in preamp or an active-type electric guitar, or when using an effects pedal, for example, between the guitar and this unit, set the **LINE-GUITAR** switch on the rear panel to **LINE**.

## Assigning inputs

When using this unit, "assigning inputs" means setting the recording source for each track to **INPUT A to H** on the Assign screen.

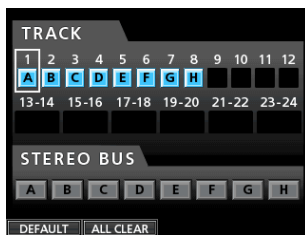

Assign screen

### NOTE

- In the initial settings, the recording sources of the track 1 to 8 are assigned to the inputs A to H (**INPUT A to H**), in that order.
- The assignment settings are saved when you save a song or turn the unit off. Likewise, the assignments settings are loaded when you load a song.

This unit can simultaneously record a maximum of eight tracks. You can assign one input source to multiple tracks simultaneously. However, you cannot assign multiple input sources to the same track. You can also assign an input source to a stereo bus.

## Assigning to a mono track

Tracks 1 to 12 are mono tracks.

1. When the recorder is stopped, press the **ASSIGN** button to open the Assign screen.
2. Use the **SELECT** button of each track or the **CURSOR** (**▲/▼/◀/▶**) buttons to move the cursor to the mono track you want to assign a recording source.
3. Press the **SOURCE** button of the desired input (**INPUT A to H**) or turn the **JOG/DATA** dial to set the input source of each mono track.

4. After making the settings, press the **ASSIGN** button or the **HOME** button to return to the Home screen.

## Assigning to a stereo track

Tracks **13/14** to **23/24** are stereo tracks.

Stereo tracks are always simultaneously recorded.

You cannot record to a single track of a stereo track pair.

1. When the recorder is stopped, press the **ASSIGN** button to open the Assign screen.
2. Use the **SELECT** button of each track or the **CURSOR** (**▲/▼/◀/▶**) buttons to move the cursor to the stereo track you want to assign a recording source.
3. Press the **SOURCE** button of the desired input (**INPUT A to H**) or turn the **JOG/DATA** dial to set the input source of each stereo track.

Options: A/A, A/B, B/B, C/C, C/D, D/D, E/E, E/F, F/F, G/G, G/H, and H/H

4. After making the settings, press the **ASSIGN** button or the **HOME** button to return to the Home screen.

### NOTE

- You can assign a single input source to multiple tracks by keeping the **SOURCE** button of the desired input (**INPUT A to H**) pressed and pressing the **SELECT** buttons of multiple tracks.
- However, you cannot assign multiple input sources to the same track.

## Assigning to a stereo bus

1. When the recorder is stopped, press the **ASSIGN** button to open the Assign screen.
2. Use the **STEREO SELECT** button or the **CURSOR** (**▲/▼/◀/▶**) buttons to move the cursor to the **STEREO BUS** display area.
3. Use the **CURSOR** (**◀/▶**) buttons to move the cursor to the input source you want assign to the stereo bus.
4. Press the **SOURCE** button of the desired input (**INPUT A to H**) or turn the **JOG/DATA** dial to set the input source to the stereo bus.
5. After making the settings, press the **ASSIGN** button or the **HOME** button to return to the Home screen.

## Checking the assignment

You can check the current assignment on the Assign screen.

The assigned input source name (A to H) is displayed on the level meter display area of each track on the Home screen.

### NOTE

When power is turned off (except when the song protection function is enabled), the current song is saved and all song-related settings are stored.

The next time you turn the power on, all stored settings will be restored.

## Canceling an assignment

When the Assign screen is displayed, pressing the **F1 (DEFAULT)** button restores the initial settings. Likewise, pressing the **F2 (ALL CLEAR)** button clears all assignment settings.

## Using phantom power

When connecting a condenser microphone that requires phantom power, press the **PHANTOM (+48V)** for **INPUT A to D** or **INPUT E to H** when the recorder is stopped to turn the phantom power on or off.

When you turn the phantom power on, **PHANTOM (+48V)** button becomes lit and phantom power is supplied to the XLR jacks of **INPUT A to D** and/or **INPUT E to H**.

When the **GUITAR** indicator is lit, however, **INPUT H** will not receive phantom power even if phantom (+48V) power is **ON** (indicator lit) for **E-H**.

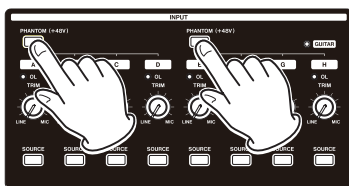

### CAUTION

- Turn the **STEREO** fader down before turning phantom power on or off. Depending on the microphone, a loud noise could occur, resulting in damages to the equipment and people's hearing.
- Do not connect or disconnect a microphone when phantom power is on. This could cause a loud noise and damage the equipment.
- Turn phantom power on only when using a condenser microphone that requires phantom power.
- Do not supply phantom power to an unbalanced dynamic microphone. Doing so could cause a malfunction.
- Supplying phantom power to some types of ribbon microphones could cause a malfunction. Do not supply

phantom power to a ribbon microphone if you are in doubt.

## Monitoring

Monitoring is an important element of the recording and mastering process. You can use an external monitoring system (self-powered monitor speakers, amplifier equipped with speakers, etc.) or headphones to monitor the sound of this unit.

Use the **MONITOR LEVEL** knob to adjust the level of the monitoring system.

### Monitor selection

Besides the stereo bus, this unit allows you to monitor the bounce bus (see "Bouncing tracks" on page 53) or Effect Sends 1/2.

In the Effect Sends monitoring, you can monitor the signals being sent to the effects.

1. When the Home screen is displayed, press the **MONITOR SELECT** button to open the **MONITOR SELECT** pop-up window.



2. Use the **JOG/DATA** dial or the **CURSOR (▲/▼)** buttons to select the monitor destination.

#### STEREO (default)

Select this to monitor the stereo signal of the stereo bus.

#### BOUNCE

Select this to monitor the stereo signal of the bounce bus.

#### EFFECT SEND 1

Select this to monitor the mono signal of the Effect Send 1.

#### EFFECT SEND 2

Select this to monitor the mono signal of the Effect Send 2.

3. After selecting the monitor destination, press the **MONITOR SELECT** button to return to the Home screen.

# 6 - Basic Recording

## OL indicators and level meters

You can check the audio signal levels of this unit through the **OL** indicators for **INPUT A** to **H** and the level meters shown on the display.

The level meters allow the signal levels to be monitored, and they can also be used to confirm whether signals are being input into the unit. For example, if the level meters assigned to inputs **A** to **H** on the Home screen are moving, this means that signals are being input into the unit even if you cannot hear anything when monitoring.

As shown below, if a red line "■" appears at the top of a level meter, the level is too high (it stays on screen for a while before automatically disappearing). If the level is too loud, the sound might be distorted, so lower the level until the red line "■" stops appearing.

If an **OL** indicator lights, the signal from the input source might be too loud or the **TRIM** knob set too high.

If the **OL** indicator lights even though the **TRIM** knob is set to the **LINE** position, the input source signal is too loud, so lower the volume on the input source.

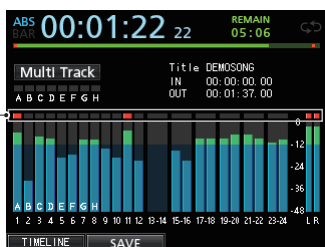

Overload indication

### Overload indicators (A to H)

The overload indicators for inputs **A** to **H** on the display show the overload of the input level (**INPUT A** to **H**) of this unit.

Use the **TRIM** knobs of **INPUT A** to **H** or the output volume controls of the input sources to adjust the level.

### Track level meters (1 to 23/24)

These level meters show either the playback signal levels or the input signal levels of the corresponding tracks. The signal levels shown by the track level meters depend on the operating conditions as shown below.

REC button	Transport status	Level meter display contents
Unlit	Playback	Track playback signal
Flashing (recording standby)	Playback	Track playback signal (Auto Monitor ON) Track input signal + playback signal (Auto Monitor OFF)
Flashing (recording standby)	Stopped	Track input signal

Lit (recording)	Recording	Track input signal
-----------------	-----------	--------------------

### NOTE

During playback signal display, since the level of the signal being recorded on the track is shown, the level cannot be changed.

During input signal display, you can change the levels with the **TRIM** knobs of **INPUT A** to **H**.

### Stereo level meter (L, R)

This meter shows the output level of this unit's stereo bus.

Adjust the output level with the **STEREO** fader.

## Setting the Mixer screen

To change the mixer target, press the **SOURCE** button for the desired input or press the **SELECT** button for the desired track.

### Using EQ (equalizer)

**INPUT A** to **INPUT H** and track 1 to track 23/24 have a 3-band EQ (equalizer).

The equalizer setting is made on the Mixer screen.

1. Press the **MIXER** button to open the Mixer screen.

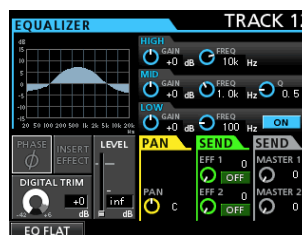

2. Press the **SOURCE** button of **INPUT A** to **H** or the **SELECT** button of each track to open the Mixer screen to set the corresponding equalizer.
3. Press the **EQUALIZER ON/OFF** button on the right side of the **LOW** knob to turn the equalizer on/off.

The **EQ** (equalizer) parameters are as follows.

	GAIN	FREQ
<b>HIGH</b>	High gain Setting range: ±12dB (Default: 0dB)	High frequency Setting range: 1.7kHz to 18kHz (Default: 10kHz)
<b>MID</b>	Mid gain Setting range: ±12dB (Default: 0dB)	Mid frequency Setting range: 32Hz to 18kHz (Default: 1.0kHz)
<b>LOW</b>	Low gain Setting range: ±12dB (Default: 0dB)	Low frequency Setting range: 32Hz to 1.6kHz (Default: 100Hz)



Use the **SELECT** button of each track to select the desired track.

Press the **SOURCE** button of each **INPUT** to change the input.

Use the **HIGH**, **MID**, and **LOW GAIN** knobs to adjust the gain.

Use the **HIGH**, **MID**, and **LOW FREQ** knobs to adjust the frequency.

Use the **MID Q** knob to set the **MID FREQ** bandwidth.

**Setting range:** 0.25 to 16 (Default: 0.5)

Press the **EQUALIZER ON/OFF** button to turn the equalizer on or off.

### NOTE

- "Q" refers to the center frequency of the equalizer divided by the bandwidth. A high Q value reduces the cut and/or boost applied to the frequencies. Depending on the equalizer setting, the graph at the top of the screen changes.
  - If you press the **F1 (EQ FLAT)** button, all the settings on the open Mixer screen will be restored to their default values.
3. After making the settings, press the **HOME** button to return to the Home screen.

## DIGITAL TRIM setting (Track only)

1. Use the **CURSOR** (**▲/▼/◀/▶**) buttons to move the cursor to the **DIGITAL TRIM** display area.

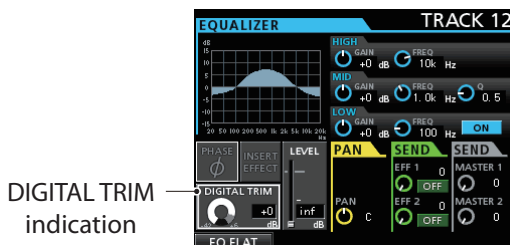

2. Turn the **JOG/DATA** dial to set the value.  
**Setting range:** -42dB to +6dB (Default: 0dB)

### NOTE

Normally, set to 0dB, but if you want to boost the equalizer, we recommend that you lower the gain to prevent digital clipping.

## Built-in Send Effects and External Effects

This unit has two external effect send systems (**EFF 1** and **EFF 2**) and a built-in effect send function (**INSERT EFFECT**). You can adjust send levels for each track. For details about the built-in send effects, see "Send effects" on page 65.

1. Use the **CURSOR** (**▲/▼/◀/▶**) buttons to move the cursor to the **EFFECT** item on the **SEND EFF 1/ EFF 2** display area.

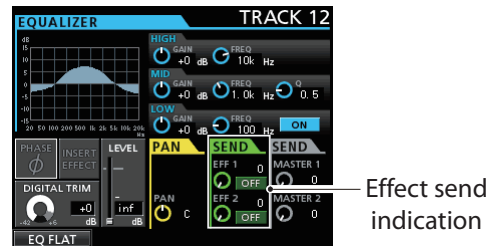

2. Turn the **JOG/DATA** dial to set the effect.

**Options:** OFF (default), PRE, POST

### PRE

This sends the track pre-fader signal to the effect send bus. The effect send signal level is not affected by the track fader.

### POST

This sends the track post-fader signal to the effect send bus. The effect send signal level is affected by the track fader.

3. Use the **SEND EFF 1/EFF 2** to adjust the send level.

**Setting range:** 0 to 127 (Default: 0)

4. Use the **SEND MASTER 1/MASTER 2** to adjust the send master level.

**Setting range:** 0 to 127 (Default: 0)

## Setting built-in effects

1. Use the **CURSOR** (**▲/▼/◀/▶**) buttons to move the cursor to the **INSERT EFFECT** display area.

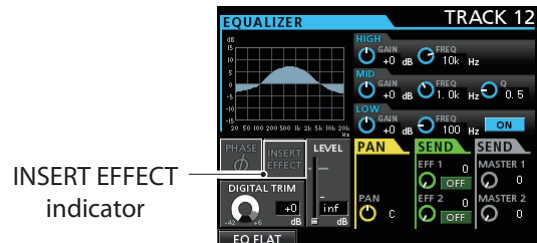

2. Turn the **JOG/DATA** dial to set the built-in effect.

**Options:**

OFF: **INSERT EFFECT** indicator unlit (default)

ON: **INSERT EFFECT** indicator lit

# 6 - Basic Recording

## Setting the stereo position

Use the PAN parameter to set the stereo position. The full left value is L63, and the full right value is R63. The center position is shown by C.

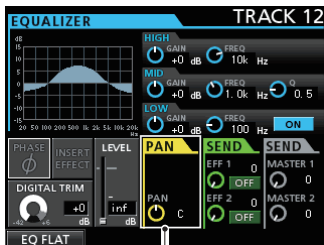

PAN indication

Turn the PAN knob to adjust the stereo position.

**Setting range:** L63 to C to R63 (Default: C)

## Changing the signal phase

When the phase is inverted due to the mic wiring or other reason, use the PHASEØ display area to correct the phase.

1. Use the CURSOR (▲/▼/◀/▶) buttons to move the cursor to the PHASEØ display area.

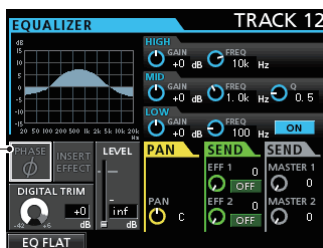

PHASEØ indicator

2. Turn the JOG/DATA dial to change the built-in signal phase.

### Options:

PHASEØ indicator unlit (default): Normal phase

PHASEØ indicator lit: Inverted phase

## Checking the fader level

Check the level on the LEVEL display area on the Mixer screen for each track. Operations cannot be made on this display.

Operations for LEVEL on the Mixer screen for each input (INPUT A to H) are explained below.

1. Use the CURSOR (▲/▼/◀/▶) buttons to move the cursor to the LEVEL display area.

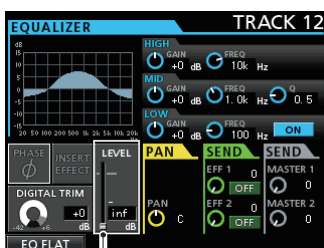

Fader level indication

2. Turn the JOG/DATA dial to adjust the level.

**Setting range:** inf to +6.0dB

When playing back a track, in the initial settings, the positions of the faders (physical faders) on the top panel and the actual level of the faders (internal faders) are always matched, but a fader group or MIDI command sent by a remote control to the unit could make them to differ. Even in this case, when you move a physical fader, the internal fader matches the physical fader value, and thereafter the physical fader controls the level.

### CAUTION

A sudden level change may occur.

## Solo

Press the SOLO button to select the Solo mode. The SOLO button becomes lit.

In Solo mode, the REC button of each track works as a SOLO button, so you can monitor the signal of the desired track.

The Solo mode of this unit is a solo-in-place monitor, so all other tracks are muted except the one whose REC button was pressed.

1. When the Home screen is displayed, press the SOLO button to select the Solo mode.

In Solo mode, the SOLO button becomes lit.

2. Press the REC button for the track you want to turn soloing on/off.

When Solo mode is activated, the MUTE/SOLO indicator of the track whose REC button was pressed lights.

### To cancel soloing

In Solo mode, press the SOLO button or the REC button to which track solo is enabled.

When Solo mode is deactivated, the MUTE/SOLO indicator of the track whose REC button was pressed goes off.

## Muting tracks

1. Press the MUTE button to enter Mute mode.

In Mute mode, the MUTE button becomes lit.

2. Press the REC button for the track you want to turn muting on/off.

When muting is turned on, the MUTE/SOLO indicator of the track whose REC button was pressed lights.

### To cancel muting

Press the MUTE button to enter the Mute mode.

Press the REC button of a muted track to cancel muting (its MUTE/SOLO indicator goes off).

When solo is activated during muting, you can hear the sound, but this does not mean that muting was canceled.

## Rehearsing the recording

This unit has a recording rehearsal function, so you can rehearse without actually recording.

The rehearsal function is specially useful for the auto punch recording and other recording operations. (See "Auto punch in/out" on page 57.)

In a rehearsal, monitoring and other recording operations are the same as for the actual recording, but the input signal is not recorded.

To rehearse, press the **REHEARSE** button so that the button becomes lit.

When you record in Rehearsal mode, the **RECORD (●)** button flashes instead of becoming lit.

After finishing your rehearsal, press the **REHEARSE** button to cancel the Rehearsal mode.

## Making the first recording

Before beginning the following recording procedures, connect a recording source (a microphone or guitar) to an input, assign that input as the recording source for a track, and prepare your monitoring equipment.

### 1. Press the REC button of the track that you want to record on.

The **REC** button flashes red and the unit enters recording standby.

A maximum of eight tracks can be recorded simultaneously.

When the **REC** buttons of eight tracks are flashing, the other **REC** buttons become inoperative.

### 2. Set the recording level.

Use the **TRIM** knobs of **INPUT A** to **H** to adjust the input level.

When doing this, adjust the level appropriately by checking the **OL** indicator on the upper left corner of the **TRIM** knob.

At the same time, confirm that the sound heard from the headphones or monitoring system is not distorted, and that an unintentional sound effect is not set up.

#### NOTE

The level meter of the track that has an input source assigned to it shows the input level after the application of INPUT EQ (equalizer).

The **OL** indicator lights if the input is too loud.

If the **OL** indicator stays lit even when you lower the **TRIM** knob for that input, lower the input source signal level.

### 3. Press the REHEARSE button to select the Rehearsal mode.

In Rehearsal mode, **Rehearsal** appears on the upper left corner of the Home screen.

### 4. Press the RECORD (●) button.

The recording rehearsal starts, the **RECORD (●)** button flashes, and the **PLAY (▶)** button becomes lit. The **REC** button of the track that will be recorded stays flashing.

### 5. After rehearsing your recording, press the STOP (■) button.

### 6. Press the REHEARSE button to exit the Rehearsal mode.

**Rehearsal** disappears from the upper left corner of the Home screen.

### 7. Press the RECORD (●) button.

The recording starts, the **RECORD (●)** button and the **PLAY (▶)** button become lit.

The **REC** button of the recorded track stops flashing and becomes lit.

### 8. After finishing your recording, press the STOP (■) button.

### 9. If you want to check a part of the recording, use the REW (◀) (TO ZERO) button, for example, to move to it (locate).

#### TIP

Use the TO LAST REC function to move to the last recording position and the TO ZERO function to return to the start of the song (00:00:00). For more information about the rewind/fast-forward and locate functions, see "Returning to zero (TO ZERO) and returning to last recording position (TO LAST REC)" on page 55.

### 10. Press the PLAY (▶) button to play back the recorded track.

Use the track faders and **STEREO** fader to adjust the playback level.

Use the **MONITOR LEVEL** knob or the volume control on your monitoring system to set the final monitoring volume.

Use the **PAN** knobs on the corresponding Mixer screen to set the stereo position of each track between the left and right speakers.

#### NOTE

- The track **PAN** knobs on the Mixer screen of each track and the track faders control the recorded track's playback output signal or the monitoring sound of the input signal. They do not control the signal being recorded to the track.
- If you are not satisfied with the recorded sound, repeat the procedure above from the beginning.

## 6 - Basic Recording

### Multitrack recording

You can record new sounds to different tracks while playing back already recorded tracks.

### Setting the tracks for recording

- Press the **REC** buttons of the already recorded tracks to turn off the **REC** buttons.
- Press the **REC** buttons of the tracks that you want to record to put them into recording standby (the **REC** buttons start flashing).

### Setting track pan and level

Use the track faders and **PAN** knobs on the Mixer screen of the already recorded tracks to adjust the levels and stereo positions for monitoring the playback signals while making new recording.

### Input selection and assignment

Use the procedures described earlier in this chapter to assign input sources to the recording tracks.

### Setting input levels

After making the settings, press the **PLAY** (▶) button to start playback.

Just as though you were recording, you can monitor the sound of already recorded tracks playing back and the input sources on the tracks for recording, allowing you to check the monitoring balance and volume.

### Recording

Press the **RECORD** (●) button.

Now you can start recording to another track while monitoring the playback signal.

### Undoing an operation

This unit allows you to undo an operation or recording that was not successful or satisfactory. Many ordinary operations, including editing and recording, can be canceled (undone).

This unit has two types of undo functions. Single undo can be performed by a simple button press, while multi-undo allows you to return to a specific past operation and undo the operations that occurred after it.

You can use the undo function for the following operations.

- Track editing operations (functions described in this chapter)
- Recording operations (including track bouncing)
- Auto punch in/out operations

All these operations are stored on the SD card as song information. Even when you turn the unit off (standby), the previous operations are stored and can be undone when you turn on the unit again.

When listening to a part that you replaced in your last recording, for example, you find that the previous take was better. In such a case, you can use the undo function to easily get your previous take back.

#### NOTE

The **UNDO/REDO** button becomes lit when a single undo or multi-undo has been performed.

### Setting the undoing feature

1. When the recorder is stopped, press the **MENU** button to open the **MENU** screen.
2. Use the **JOG/DATA** dial or the **CURSOR** (▲/▼/◀/▶) buttons to select (green highlight) **PREFERENCE**, and then press the **F4** (▶) button.



The **PREFERENCE** menu screen appears.

3. Use the **CURSOR** (▲/▼) buttons to select (blue highlight) **Undo History**.

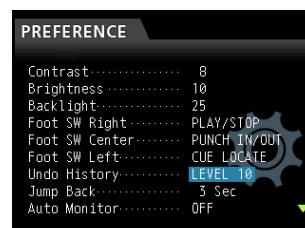

## 4. Set canceling (undo) operations.

### LEVEL 1 (Default)

HISTORY LIST is not displayed when you press the **UNDO/REDO** button. In other words, this returns the unit to the state before the last operation (single operation). (To cancel the undo, perform REDO.)

### LEVEL 10

When you press the **UNDO/REDO** button, HISTORY LIST appears and you can return to the state before up to 10 past operations.

#### NOTE

Even when you change from LEVEL 10 to LEVEL 1, the history for a maximum of 10 actions remains stored. The position of the cursor on the list shows the current position.

## Undoing the last operation (single undo)

Press the **UNDO/REDO** button to return to the state before the last operation.

After doing this, the **UNDO/REDO** button lights, showing that redo (see below) is possible.

### ■ Canceling an undo operation (redo)

Press the **UNDO/REDO** button when it is lit.

The last action is enabled again, the unit returns to its newest state, and the **UNDO/REDO** button becomes unlit.

## Undoing previous operations (multi-undo)

To perform the multi-undo, first you must set Undo History on the PREFERENCE menu to LEVEL 10. (See "Setting the undoing feature" on page 50.)

1. Set Undo History on the PREFERENCE menu to LEVEL 10.

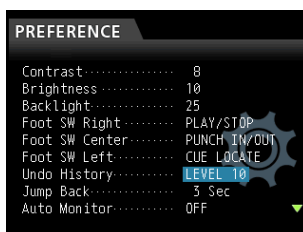

2. When the Home screen is displayed, press the **UNDO/REDO** button to display HISTORY LIST.

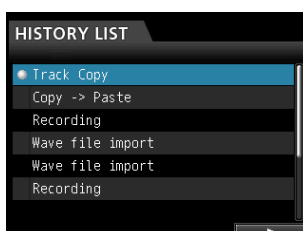

The maximum number for the undo history is 10. In other words, a maximum of 10 operations can be undone.

This operation is called "multi-undo" because it allows you to undo multiple events and return to an earlier state.

3. Use the JOG/DATA dial to select (blue highlight) the event that you want to return to (all events after the selected event will be undone).
4. Press the F4 (▶) button.

The multi-undo is performed and the song is restored to the state just after the selected event was performed.

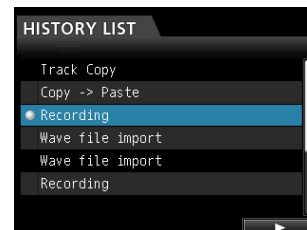

In this state, the **UNDO/REDO** button lights.

The event information undone through the above operation is not erased. The unit has simply been returned to a previous state.

On the HISTORY LIST screen, ● icon appears next to the last event after undoing. When the most recent event is selected on HISTORY LIST, pressing the F4 (▶) button returns to the most recent operation.

#### CAUTION

- When saving a song, a maximum of 10 operation history events can be saved with the song data. If the number of operation history events exceeds 10, the oldest events in the history are erased. These erased events cannot be restored.
- Since the history information is stored as the song information, even when the power is turned off (standby), the previous operation remains stored, so the undo operation is also possible next time the power is turned on.
- If you perform an operation that is added to the history when the **UNDO/REDO** button is lit after a multi-undo operation has been performed, the history after the multi-undo will be erased.



# 7 - Recorder Functions

## Punching in and out

Punching in/out is a technique to replace a part of an already recorded track.

Start playback and when you reach the part that you want to replace, switch to record (punch in), then switch back to playback (or stop) when you finish the part that you want to replace (punch out).

**1. Decide what part of the track you plan to replace.**

Choose a point to begin where the new recording can sit well with the existing recording.

**2. Press the REC buttons of the tracks that you want to replace to put them into recording standby (REC buttons start flashing).**

**3. Start playback before the part you want to replace.**

**4. When the part you want to replace is reached, press the RECORD (●) button and start your performance.**

The unit switches to recording (punch in).

**5. When you finish the replacement recording, press the PLAY (▶) button.**

The unit switches to playback (punch out).

**TIP**

You can also press the **STOP (■)** button to punch out at the end of the replacement recording.

## Using a foot switch to punch in/out

You can connect the dedicated foot switch (TASCAM RC-3F) to the **REMOTE** jack on the front panel and use it to punch in and out.

In step 4 above, step on the foot switch instead of pressing the **RECORD (●)** button, and in step 5, step on the foot switch again instead of pressing the **PLAY (▶)** button.

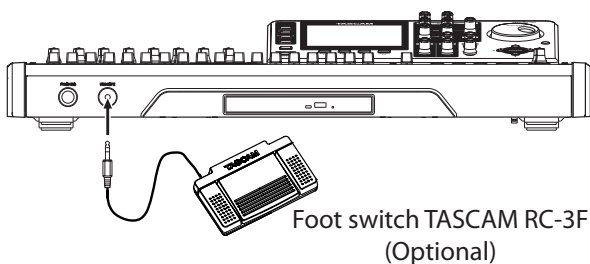

**NOTE**

Step on the switch (pedal) that you have set to **PUNCH IN/OUT** in the foot switch settings. In the initial settings, the pedal C (center) is set to **PUNCH IN/OUT**. (See "Setting the foot switch" below.)

## Setting the foot switch

Set the foot switch on the **PREFERENCE** screen.

**1. When the recorder is stopped, press the MENU button to open the MENU screen.**

**2. Use the JOG/DATA dial or the CURSOR (▲/▼/◀/▶) buttons to select (green highlight) PREFERENCE, and then press the F4 (▶) button.**



The **PREFERENCE** screen appears.

**3. Use the CURSOR (▲/▼) buttons to select (blue highlight) Foot SW Right.**

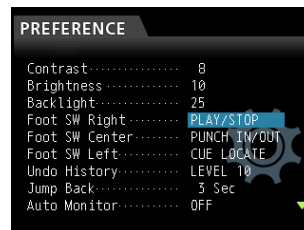

**4. Use the JOG/DATA dial to select the function that you want to assign to the pedal R (right) of the TASCAM RC-3F foot switch.**

**Options:** PLAY, REC, STOP, FF, REW, PUNCH IN/OUT, PLAY/STOP (Default: Pedal R), CUE LOCATE

**5. In the same way, set the functions for the pedal C (center) in Foot SW Center, and for the pedal L (left) in Foot SW Left.**

**Options:** PLAY, REC, STOP, FF, REW, PUNCH IN/OUT (Default: Pedal C), PLAY/STOP, CUE LOCATE (Default: Pedal L)

**6. After making the settings, press the HOME button to return to the Home screen.**

**■ Foot switch function list**

Function	Description
PLAY	Same as the unit's <b>PLAY (▶)</b> button
REC	Same as the unit's <b>RECORD (●)</b> button
STOP	Same as the unit's <b>STOP (■)</b> button
FF	Same as the unit's <b>F FWD (▶▶)</b> (TO <b>LAST REC</b> ) button
REW	Same as the unit's <b>REW (◀◀)</b> (TO <b>ZERO</b> ) button
PUNCH IN/OUT	Punches in when pressed during playback, punches out when pressed during recording.
PLAY/STOP	Starts playback when stopped, stops in other states.
CUE LOCATE	Locates the last point where playback started.

## Bouncing tracks

Like many multitrack recorders, this unit allows you to bounce tracks (ping-pong recording technique). Track bouncing allows you to collect signals of multiple tracks and use them to perform new mono or stereo recording. In this way, you can virtually record more than 24 tracks. Note, however, that the original tracks cannot be separated again.

In Bounce mode, the recording source track signals pass through the mixer tracks via the bounce bus, and they are sent to the bounce tracks.

If you make a mistake, you can use the undo function of this unit to undo the incorrect operation (see "Undoing an operation" on page 50).

## Performing the track bouncing

1. When Recorder mode is Multi Track mode and the recorder is stopped, press the **BOUNCE** button.

The Recorder mode switches to Bounce mode.

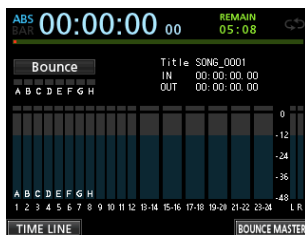

### NOTE

In Bounce mode, **Bounce** appears on the upper left corner of the Home screen.

2. Press the **REC** button of the track that you want to make the bounce destination, which will cause the **REC** button to flash.

When making a stereo bouncing, press two **REC** buttons for the tracks from 1 to 12, or press one **REC** button for a stereo track from 13/14 to 23/24, which will cause the button(s) to flash.

For a mono bouncing (single track bouncing), press one of the **REC** buttons for tracks from 1 to 12 so that its button starts flashing.

You should also set the fader of the bounce destination track to 0 dB.

### NOTE

Though the track fader and **STEREO** fader settings of the bounce destination affect the monitor volume, they do not affect the recording level. If you want the monitoring level to be the same as the recording level, set the fader for the bounce destination track to 0 dB.

3. Press the **SELECT** button to specify the bounce source.

Except for the bounce destination, you can select from all tracks and inputs as bounce sources. To set an input as a bounce source, assign it to a stereo bus and press its **SOURCE** button.

Use the track fader and the **PAN** knobs on the Mixer screen to adjust the track specified as the bounce destination.

For stereo bouncing, the lower numbered track becomes the left channel.

In the case of mono bounce, set the **PAN** knob on the Mixer screen of the track that will be the bounce source completely to the **L** side.

To adjust the bounce master level when in Bounce mode, press the **F4** (**BOUNCE MASTER**) button to show a fader. Use the **JOG/DATA** dial to adjust it.

### CAUTION

If the bounce source is selected before selecting the destination, the audio signals of the bounce source are not output from the **STEREO OUTPUT** jack or monitor's **STEREO** until you select the bounce destination.

4. Locate to the point where you want to start the bounce and press the **RECORD** (●) button to execute the track bounce.

The track bouncing starts.

Press the **STOP** (■) button at the position where you want to end the bounce.

## Checking the result

Mute the bounce original tracks and play back the song. (See "Muting tracks" on page 48.)

If you are not satisfied with the result because you think the balance between the instruments or the pan setting is not good, for example, undo the operation. (See "Undoing an operation" on page 50.)

If you are satisfied with the result, press the **BOUNCE** button to return to the Multi Track mode of the Recorder mode.

Once the track bounce is completed, you can make new recordings over (overwrite) the other tracks, except for the bounced track.

### TIP

If it is possible that you might need the original tracks at some time later, before bouncing tracks, copy or back up the song data to a computer. (See "Copying songs" on page 40 and "Connecting to a computer" on page 80.)

### CAUTION

To monitor the original sound recorded on the bounce track, set the monitor destination to **BOUNCE** so that you can monitor the bounce bus.



# 7 - Recorder Functions

## Direct Location Function

You can specify a time or measure/beat to be located without using marks. On the Home screen, use the **JOG/DATA** dial to specify the location point.

The Home screen counter has two display types: **ABS** (absolute time) and **BAR** (bar/beat).

The **BAR** display is based on the metronome setting. In **BAR** mode, you can locate a position in beat units. The current position of the recorder is shown as a time (measure-beat) at the top of the Home screen. The tempo is also displayed.

The **ABS** display is based on the absolute time. In **ABS** mode, you can locate a position in frame units. The current position of the recorder is shown as a time (hours : minutes : seconds) on the top of the Home screen (30 frames per second).

You can specify a time in this time display area and move the current position of the recorder.

## Locating directly a specified time

In **ABS** mode, you can locate a specified time directly through the following two methods. This direct location cannot be performed by this method during recording.

1. Press the **HOME** button to open the Home screen.
2. **ABS** is displayed on the left side of the counter of the Home screen.

If it is not displayed, press the **METRONOME** button to open the **METRONOME** screen.

Use the **CURSOR** (**▲** / **▼**) buttons to select **BAR DISP** item of the **METRONOME** screen, and then use the **JOG/DATA** dial to set it to **OFF**, which will cause **ABS** to appear.

3. Turn the **JOG/DATA** dial to change the time (the time advance speed changes according to the speed of turning the dial).
4. After setting the desired time value, press the **PLAY** (**▶**) button which will cause the playback to start.

## Locating directly a specified measure/beat

Like the time specification location in **ABS** mode, you can locate a position by specifying a music point in **BAR** mode.

You can perform the direct location of a preset point through the procedure below.

This direct location cannot be performed by this procedure during recording.

1. Press the **HOME** button to open the Home screen.
2. **BAR** is displayed on the left side of the counter of the Home screen.

If it is not displayed, press the **METRONOME** button to open the **METRONOME** screen.

Use the **CURSOR** (**▲** / **▼**) buttons to select the **BAR DISP** item of the **METRONOME** screen, and then use the **JOG/DATA** dial to set it to **ON**, which will cause **BAR** to appear.

3. The value wraps automatically when it reaches the highest or lowest value in a field.

When set to 4/4 and the beat field exceeds 04, for example, the bar value will increase by one, and the beat field will return to 01.

In the same way, when you turn the **JOG/DATA** dial to lower a value and passes through 01, the bar value will decrease and the total value will change in succession. When set to 4/4, for example, if the value drops below 01 when the cursor is located under the beat field, the bar value will decrease by one, and the beat field will return to 04.

4. After setting the desired measure/beat, press the **PLAY** (**▶**) button which will cause the playback to start.

## Location marks

This unit allows you to set up to 99 location marks in each song.

For example, you can mark the intro, vocal entry points, start of verses, etc.

## Setting a location mark

When stopped, during recording or playback, press the **MARK SET** button at the point where you want the location mark.

A mark number (**MARK xx**) appears on the Home screen (**xx** is the mark No.).

The displayed mark No. indicates the current position mark or the mark immediately before. A flag icon is also displayed above the timeline.

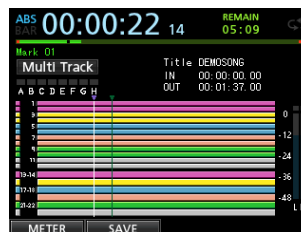

### NOTE

The marks are numbered in the order you enter them. The marks do not appear according to their position in the song. Therefore, **MARK 05** can appear before **MARK 01** in a song.

## Skipping to location marks

Press the **F FWD (▶▶) (TO LAST REC)** button or the **REW (◀◀) (TO ZERO)** button to skip to the next or previous mark.

## Deleting a location mark

You can delete marks when the recorder is stopped.

1. Press the **F FWD (▶▶) (TO LAST REC)** button or the **REW (◀◀) (TO ZERO)** button to move to the mark that you want to delete.
2. Press the **MARK SET** button to delete the location mark.

### NOTE

- Marks are displayed in time order. They do not appear in the order of their numbers.
- This operation cannot be undone. Make sure you want to execute it.

## Returning to zero (TO ZERO) and returning to last recording position (TO LAST REC)

You can easily move to the beginning of the song (00:00:00:00 = ZERO point) or to the last recording position (LAST REC point) through a simple button operation.

To return to the beginning of the song (00:00:00:00 = ZERO point), press and hold the **STOP (■)** button and press the **REW (◀◀) (TO ZERO)** button (TO ZERO function).

To return to the last recording position (LAST REC point), press and hold the **STOP (■)** button and press the **F FWD (▶▶) (TO LAST REC)** button (TO LAST REC function).

This function is useful when you want to record again after finishing recording.

## Fast forward/rewind search

During playback or stop, press the **REW (◀◀) (TO ZERO)** button or the **F FWD (▶▶) (TO LAST REC)** button to rewind or fast-forward while the button is pressed. The rewind and fast-forward speed is fixed at 10 times.

## Jog positioning

You can use the **JOG/DATA** dial to position a playback position precisely. There are two methods of positioning: viewing the track's waveform and listening to the track sounds.

## Viewing the track's waveform

1. Use the transport button or location function to move the playback position near a position where you want to cue.
2. Press the **JOG PLAY** button to enter the search mode.

You can switch between the timeline display and waveform display by pressing the **F1** key. Select the waveform display screen.



3. Press the **SELECT** button of a track whose waveform you want to view.

The waveform of the selected track appears.

If a stereo track is selected, the displayed track (odd or even) changes each time the **SELECT** button is pressed, and only the displayed track can be monitored.

4. Use the **CURSOR (◀/▶)** buttons to scale up/down the display horizontally (time) as necessary.

Press the **CURSOR (◀)** button to scale down horizontally (time), or the **CURSOR (▶)** button to scale up.

Also, use the **CURSOR (▲/▼)** buttons to scale up/down the display vertically (audio level).

Press the **CURSOR (▲)** button to scale up vertically (audio level), or the **CURSOR (▼)** button to scale down.

Scaling up makes it easier to cue the position precisely.

5. Use the **JOG/DATA** dial to find a cue point.
6. When the cue point is determined, press the **JOG PLAY** button to return to the Home screen.

## Listening to the track sounds

1. Use the transport button or location function to move the playback position near a position where you want to cue.
2. Press the **JOG PLAY** button to enter the search mode.

You can switch between the timeline display and waveform display by pressing the **F1** key. Select the timeline display screen.

3. Use the **CURSOR (◀/▶)** buttons to scale up/down the display horizontally (time) as necessary.

Press the **CURSOR (◀)** button to scale down horizontally (time), or the **CURSOR (▶)** button to scale up.

Scaling up makes it easier to cue the position precisely.

# 7 - Recorder Functions

Now, jog sounds can be heard. (Jog sound refers to a repeat playback sound of a short period.)

4. Use the JOG/DATA dial to find a cue point while changing the jog sound playback position.
5. When the cue point is determined, press the JOG PLAY button to return to the Home screen.

### NOTE

The transport button is available even in search mode. However, while the timeline is displayed, pressing the PLAY button switches between the normal playback and jog sound playback, and pressing the STOP button performs jog sound playback.

## Repeat playback

Use the repeat playback function to play the same part again and again.

The repeat playback interval is the section between the IN and OUT points.

### Setting IN/OUT points

In addition to setting the repeat playback interval, the IN and OUT points are also used to set track editing intervals and as the punch in and punch out points when automatically punching in and out. Moreover, these points are used as the start and end points of the mixdown master file when creating a master file.

You can set these points during recording, playback or when the unit is stopped.

### NOTE

The IN and OUT points cannot be set or edited in the following cases.

- In Repeat Playback mode
- In Auto Punch mode
- In Mastering mode of the Recorder mode

### Using IN/OUT points

Regardless of whether the unit is stopped, playing back or recording, when the recorder is at the desired position, press and hold the MARK SET button and press the IN or OUT button.

The position where you pressed the IN/OUT button is set and the time is displayed on the Home screen.

### Locating IN/OUT points

When stopped or during playback, press the IN or OUT button.

## Using repeat playback

1. Set the IN point and the OUT point you want to make the start and end points of the repeat playback interval, and then return to the Home screen.
2. Press the REPEAT button.

The  icon appears on the Home screen, and repeat playback starts.

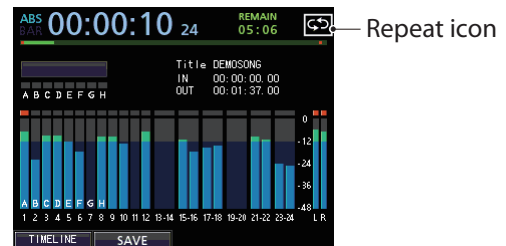

After the playback starts from the IN point and reaches the OUT point, it returns to the IN point and repeats. Playback continues to repeat between the IN and OUT points.

3. To cancel the repeat playback, press the REPEAT button, so that the  icon disappears from the Home screen.

## Moving back a few seconds for replay (jump back playback)

Press the JUMPBACK (PREVIEW) button during playback to move back a few seconds (adjustable) and restart playback (Jump back function).

If you want to hear a passage again during playback, press the JUMPBACK (PREVIEW) button to go back a few seconds and replay that passage.

1. When the recorder is stopped, press the MENU button to open the MENU screen.
2. Use the JOG/DATA dial or the CURSOR (▲/▼/◀/▶) buttons to select (green highlight) PREFERENCE, and then press the F4 (▶) button.



The PREFERENCE screen appears.

- Use the **CURSOR (▲/▼)** buttons to select (blue highlight) **Jump Back**, then use the **JOG/DATA** dial to set the value for the jump back playback.

**Options:** 1 Sec to 10 Sec, 20 Sec, 30 Sec  
(Default: 3 Sec)

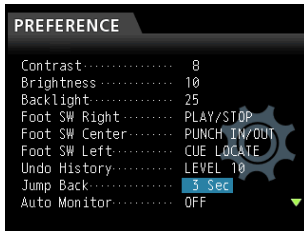

- After making the settings, press the **HOME** button to return to the Home screen.
- Press the **JUMPBACK** button during playback to move back by the time set in step 3.

## Checking cueing points (preview)

You can perform a playback to check whether the cueing is appropriately performed.

- When the recorder is stopped, press the **MENU** button to open the **MENU** screen.
- Use the **JOG/DATA** dial or the **CURSOR (▲/▼/◀/▶)** buttons to select (green highlight) **PREFERENCE**, and then press the **F4 (▶)** button.



The **PREFERENCE** screen appears.

- Use the **CURSOR (▲/▼)** buttons to select (blue highlight) **Preview Time**, then use the **JOG/DATA** dial to set the value for the preview playback.

**Preview Time:** 1 Sec to 10 Sec  
(1 sec increments) (Default: 4 Sec)

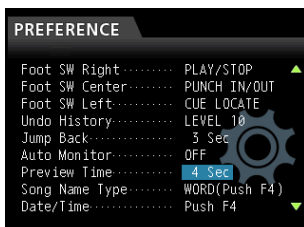

- After making the settings, press the **HOME** button to return to the Home screen.
- Perform preview playback using either of the following methods:

While playback is stopped, holding the **PREVIEW** button and pressing the **OUT** button plays from the

current time by the preview time, returns, and then stops.

While playback is stopped, holding the **PREVIEW** button and pressing the **IN** button plays from the time returned by the preview time to the current time, and then stops.

## Auto punch in/out

You can use the punch in/out function to perform an automatic record from the punch in to the punch out points you previously set.

When performing the auto punch in/out recording, the playback starts from the pre-roll point before the start recording point (punch in point) and when punch in point is reached, the record starts. After that, when the recording end point (punch out point) is reached, the unit switches to the playback of the post-roll part and stops.

In the auto punch in/out recording, the recording track monitor changes as follows.

- Pre-roll period: Track playback signal + input source signal
- Punch in ← → punch out interval: Input source signal
- Post-roll period: Track playback signal + input source signal

In the auto punch in/out function of this unit, the above monitoring changes occur not only during the actual recording, but also in the Rehearsal mode.

In Rehearsal mode, you can simulate the auto punch in/out recording. Therefore, you can rehearse your performance and also check whether the IN point and OUT point are appropriately set.

You can also use the punch in/out in combination with the repeat function. By using these functions in combination, you can repeatedly rehearse the punch in/out recording, or record the same section several times (multi-take), leaving the unit working automatically to you. When performing multitrack recording, you can choose the best from recorded takes.

# 7 - Recorder Functions

## Setting punch in/out points

There are two methods to set the punch in/out points.

### LAST REC:

This option sets the start and end points of the last recording (or recording rehearsal) as the punch in/out points.

The display returns to the Home screen, and **Auto Punch** appears on the top of the screen.

### IN - OUT:

This option sets the IN point and the OUT point as the punch in/out points. The first of these points will be used as the punch in point, and the second as the punch out point.

The display returns to the Home screen, and **Auto Punch** appears on the top of the screen.

1. **When the recorder is stopped, press the HOME button to open the Home screen.**
2. **Press the REC button for the track that you want to punch in/out automatically.**
3. **Press the AUTO PUNCH button to open the AUTO PUNCH screen.**

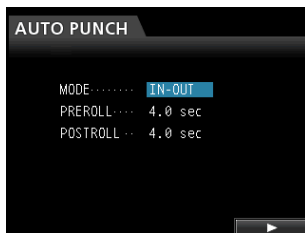

### NOTE

If you press the **AUTO PUNCH** button without any tracks in recording standby, even after that you can press the **REC** button of any track to put it into recording standby.

4. **Use the CURSOR (▲/▼) buttons to select (blue highlight) MODE, PREROLL or POSTROLL, and then use the JOG/DATA dial to select the value.**

MODE: LAST REC or IN-OUT  
PREROLL: 1.0 to 9.9 sec  
POSTROLL: 1.0 to 9.9 sec

After setting MODE, PREROLL, and POSTROLL, press the **F4 (▶)** button.

You can press the **AUTO PUNCH** button to return to the Home screen without entering Auto Punch In/Out mode.

## Checking punch in/out points

When punch in/out points are set, you can confirm the setting by pressing the **PLAY (▶)** button.

The playback starts from the pre-roll point to the post-roll point.

If you want to change the punch in/out points, locate the desired points and set the punch in/out points again.

If there are no problems about punch in/out points, pre-roll time, and post-roll time perform the rehearsal, as described below.

## Rehearsing punch in/out

You can rehearse before performing punch in/out. In the rehearsal, the monitor operates the same way as for the actual recording, but the recording is not performed.

1. **When the AUTO PUNCH button is lit and one of the tracks is in recording standby, press the REHEARSE button.**

The **REHEARSE** button becomes lit.

2. **Press the RECORD (●) button.**

Auto punch in/out rehearsal starts.

- Playback starts from the pre-roll point. You can monitor both the track playback signal and the input source signal.
- When the punch in point is reached, the monitoring changes to input source signal only, and the **RECORD (●)** button starts flashing (to indicate this is a rehearsal).
- When the punch out point is reached, the monitoring of both the track playback signal and input source signal starts, and the **RECORD (●)** button becomes unlit.
- Playback continues until the post-roll point and stops.

Before starting your rehearsal, you can press the **REPEAT** button (so that all three **AUTO PUNCH**, **REHEARSE**, and **REPEAT** buttons become lit), to repeat the rehearsal operation until you press the **STOP (■)** button.



## Performing auto punch in/out

After finishing your rehearsal, perform the auto punch in/out.

1. Press the **REHEARSE** button to turn off the **REHEARSE** button.
2. Press the **RECORD (●)** button.
  - Playback starts from the pre-roll point. You can monitor both the track playback signal and the input source signal.
  - When the punch in point is reached, the monitoring changes to input source signal only, and the **RECORD (●)** button lights.
  - When the punch out point is reached, the monitoring of both the track playback signal and input source signal starts, and the **RECORD (●)** button becomes unlit.
  - Playback continues until the post-roll point and stops.

Before starting the punch in/out recording, you can press the **REPEAT** button so that the **REPEAT** button becomes lit, and then, using the virtual track feature, repeat the punch in/out recording until 8 times (8 takes).

After the recording, you can choose your favorite take from one of the 8 takes recorded in the virtual tracks. (See "Checking a take" below.)

### NOTE

You can undo auto punch in/out operations.

## Checking a take

After recording a take, follow the procedure below to check the take.

Once the punch in/out recording is completed, the **VIRTUAL TRACK** screen appears as follows.

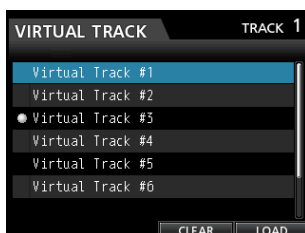

1. Use the **JOG/DATA** dial or the **CURSOR (▲/▼)** buttons to select (blue highlight) a take from the list.
2. Press the **F4 (LOAD)** to load, assign each virtual track to a physical track, and check the playback. Repeat steps 1 and 2 to check another take.
3. If you are satisfied with the result, press the **VIRTUAL TRACK** button to exit Virtual Track mode. To exit from Auto Punch mode too, press the **AUTO PUNCH** button.

If you are not satisfied with the result, press the **RECORD (●)** button again and record another take.

## Virtual tracks

This unit allows 8 virtual tracks for each track.

Since there are 8 virtual tracks for each track, you can record multiple takes of lead vocals or improvised solos, and then choose the best takes afterwards.

After recording, assign a separate virtual track to a physical track, and then record another take. By repeating this process, you can use multiple virtual tracks to hold different takes.

### NOTE

The virtual tracks are mono tracks. When assigning virtual tracks to a physical track of a stereo pair, you must assign them separately to the L and R channels.

Follow the procedure below to assign a virtual track to a physical track.

1. Press the **SELECT** button of a track you want to assign a virtual track to when the Home screen is displayed, and then press the **VIRTUAL TRACK** button.

The **VIRTUAL TRACK** screen appears.

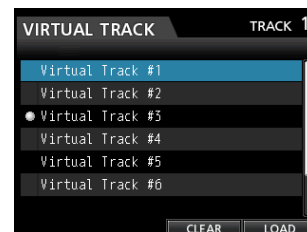

You can also press the **VIRTUAL TRACK** button first, then select a track on the **VIRTUAL TRACK** screen.

### NOTE

When creating a song, the virtual track #1 is assigned to each physical track.

Recording, playback, and editing is only possible with virtual tracks assigned to physical tracks.

You can also assign an already recorded virtual track to a physical track and record over it.

2. Use the **JOG/DATA** dial to select the virtual track that you want to assign.
3. Press the **F4 (LOAD)** button to assign the virtual track to a physical track.

The assignment to the physical track is shown by an icon on the screen.

### NOTE

- To delete a virtual track, press the **F3 (CLEAR)** button in step 3 above.
- A virtual track assigned to a physical track cannot be deleted.
- You can assign an unused virtual track. The track becomes an empty track.

# 8 - Track Editing

Editing on a conventional tape recorder in the past required advanced techniques, but with this unit editing tracks is easy and accurate.

Moreover, with a tape recorder, an editing error could not be undone, but this unit uses non-destructive editing, allowing you to edit without altering the original data. This means that the undo function can be used to correct an edit easily. (See "Undoing an operation" on page 50.)

## Overview of track editing

This unit has the following track editing functions.

- COPY/PASTE
- COPY/INSERT
- MOVE/PASTE
- MOVE/INSERT
- OPEN (Insert Silence)
- CUT (Remove Part)
- SILENCE (Erase Part)
- CLONE TRACK (Track Duplication)
- CLEAN OUT (Delete Track)

## Editing points

Among the track editing functions, COPY/PASTE, COPY/INSERT, MOVE/PASTE, and MOVE/INSERT use the IN/OUT/TO points as editing points.

OPEN, CUT, and SILENCE use IN/OUT points as editing points.

These IN/OUT points are the same IN and OUT points used during repeat playback.

### ■ IN point

The IN point is the start point for the part of the track subject to track editing.

Press and hold the **MARK SET** button and press the **IN** button to set the IN point at the current position.

### ■ OUT point

The OUT point is the end point for the part of the track subject to track editing.

Press and hold the **MARK SET** button and press the **OUT** button to set the OUT point at the current position.

### ■ TO point

- The TO point is the current position (current point).

## Basic editing procedures

1. When the recorder is stopped, press the **TRACK EDIT** button to open the **TRACK EDIT** screen.

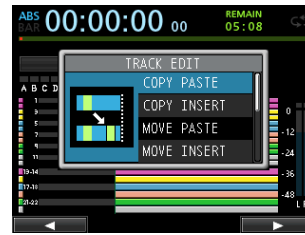

2. Use the **JOG/DATA** dial or the **CURSOR** (**▲/▼**) buttons to select (blue highlight) the desired track editing function, and then press the **F4** (**▶**) button.

The corresponding function screen appears.



COPY PASTE screen

3. Select the setting item value.

If there are multiple setting items, use the **CURSOR** (**▲/▼**) buttons to select one, and then use the **JOG/DATA** dial to set the value.

4. Press the **F2** (**YES**) button to execute the function.

### NOTE

Press the **F1** (**NO**) button to return to the **TRACK EDIT** screen without executing the function.

## Explanation of items

### ■ SOURCE Track

This is the source editing track.

The choices available depend on the editing function.

- 1 to 12: Single track
- 13/14 to 23/24: Stereo track
- You can also use the **SELECT** buttons of the tracks.
- ALL: 1 to 24 tracks



COPY PASTE screen



## ■ IN/OUT/TO

To set the IN/OUT/TO points again, exit the TRACK EDIT screen, and set them again from the beginning.

## ■ TARGET Track

This is the target editing track. In the case of OPEN, CUT, SILENCE, and CLEAN OUT, it becomes the target track itself.

The choices depend on what you have already chosen for the SOURCE Track.

When a single track is specified as the SOURCE Track, the TARGET Track options are 1 to 12 (single tracks).

When a stereo track (e.g. 13/14) is specified as the SOURCE Track, the TARGET Track options are 13/14 to 23/24 (stereo track).

- You can also use the **SELECT** buttons of the tracks.

When ALL (all tracks) is specified as the SOURCE Track, the TARGET Track option is ALL (all tracks) only.

## ■ TIMES

Set the number of times that the copied section will be pasted.

Set the number between 1 and 99.

## COPY/PASTE

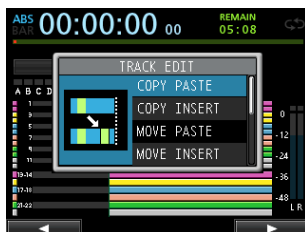
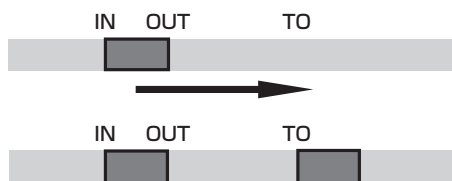

This function copies the audio data from between the IN and OUT points on the COPY source track, and pastes it on the COPY destination track starting from the TO point. This operation does not change the COPY source track.

This operation overwrites recorded data on the COPY destination track. Therefore, the length of the COPY destination track is not changed.

You can make multiple copies in a single operation.

In other words, you can overwrite the COPY destination track from the TO point with a designated number of repetitions of the COPY data.

The following parameters are used in this operation.

- **SOURCE Track** (1 to 12, 13/14 to 23/24, ALL)
- **IN/OUT/TO**
- **TARGET Track**
- **TIMES**

## COPY/INSERT

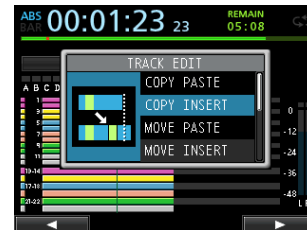
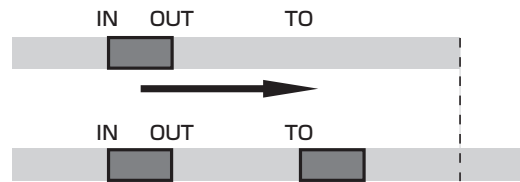

This function copies the audio data from between the IN and OUT points on the COPY source track, and inserts it on the COPY destination track starting from the TO point. This operation does not change the COPY source track.

This operation inserts recorded data into the COPY destination track. The recorded data on the COPY destination track after the TO point is offset by the amount of time used by the inserted audio data. Therefore, the COPY destination track becomes longer.

You can make multiple copies in a single operation. In other words, you can insert a designated number of repetitions of the COPY data into the COPY destination track from the TO point.

The following parameters are used in this operation.

- **SOURCE Track** (1 to 12, 13/14 to 23/24, ALL)
- **IN/OUT/TO**
- **TARGET Track**
- **TIMES**

# 8 - Track Editing

## MOVE/PASTE

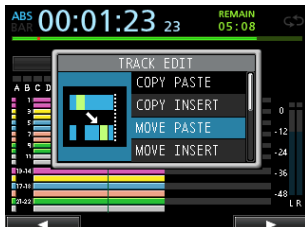
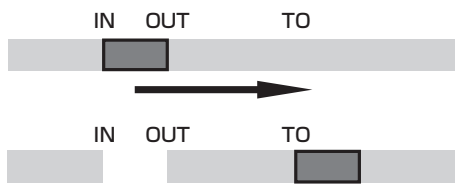

The audio data between the IN and OUT points on the MOVE source track is removed and pasted on the MOVE destination track starting from the TO point. This operation leaves a silence between the IN and OUT points on the MOVE source track.

This operation overwrites recorded data on the MOVE destination track. Therefore, the length of the MOVE destination track is not changed.

The following parameters are used in this operation.

- **SOURCE Track** (1 to 12, 13/14 to 23/24, ALL)
- **IN/OUT/TO**
- **TARGET Track**

## MOVE/INSERT

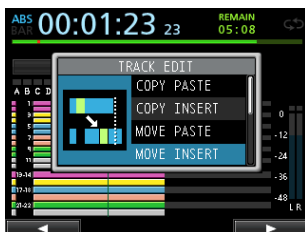
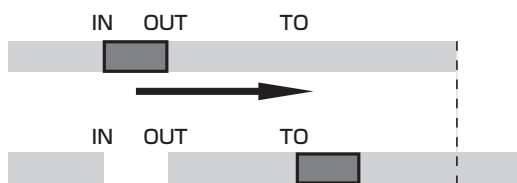

The audio data between the IN and OUT points on the MOVE source track is removed and inserted in the MOVE destination track starting from the TO point. This operation leaves a silence between the IN and OUT points on the MOVE source track.

This operation inserts recorded data into the MOVE destination track starting from the TO point. Therefore, the MOVE destination track becomes longer.

The following parameters are used in this operation.

- **SOURCE Track** (1 to 12, 13/14 to 23/24, ALL)
- **IN/OUT/TO**
- **TARGET Track**

## OPEN (Insert Silence)

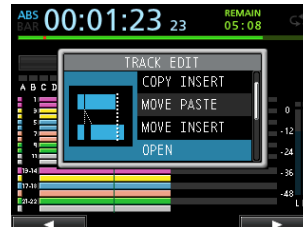
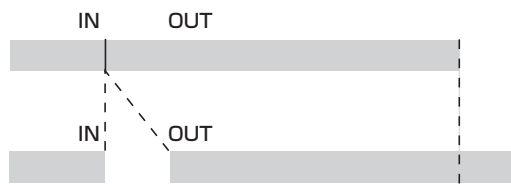

This function inserts silence between the IN and OUT points on the selected track.

This function splits the track at the IN point and shifts the recorded data after the IN point to after the OUT point. Therefore, the track becomes longer.

The following parameters are used in this operation.

- **TARGET Track** (1 to 12, 13/14 to 23/24, ALL)
- **IN/OUT**

## CUT (Remove Part)

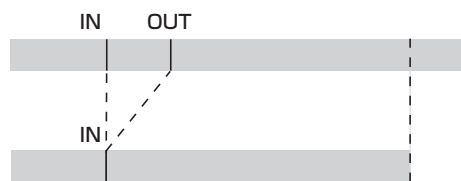

This function cuts (deletes) the audio data between the IN and OUT points on the selected track, and shifts the remaining recording after the OUT point forward to the IN point. Therefore, the track becomes shorter.

The following parameters are used in this operation.

- **TARGET Track** (1 to 12, 13/14 to 23/24, ALL)
- **IN/OUT**

## SILENCE (Erase Part)

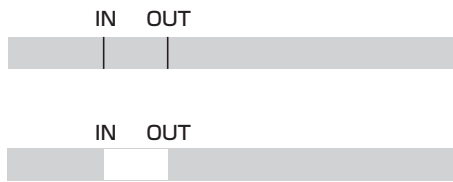

This function cuts (deletes) the audio data between the IN and OUT points on the selected track.

This is the same as leaving silence between the IN and OUT points, as though there had been no recording.

This operation does not change the length of the track.

The following parameters are used in this operation.

- **TARGET Track** (1 to 12, 13/14 to 23/24, ALL)
- **IN/OUT**

### TIP

You can use this function to delete short noises, for example.

## CLEAN OUT (Delete Track)



Use this function to completely erase the selected track.

This deletes the entire track, so IN/OUT/TO points have no effect.

The following parameters are used in this operation.

- **TARGET Track** (1 to 12, 13/14 to 23/24, ALL)

## CLONE TRACK (Track Duplication)



Use this function to duplicate a single track or a stereo track to a different track.

This copies the entire track, so the IN/OUT/TO points have no effect.

The following parameters are used in this operation.

- **SOURCE Track** (1 to 12, 13/14 to 23/24)
- **TARGET Track**

### NOTE

If you choose the same track for both SOURCE Track and TARGET Track, Same Track appears and the operation cannot be executed.

# 9 - Using Built-In Effects

This chapter explains the dynamic effects, guitar effects, and send effects that can be applied to individual mic and guitar inputs.

You can select one of the four types of dynamic effects (COMPRESSOR, NOISE SUPPRESSOR, DE-ESSER, EXCITER) to apply to all inputs (**INPUT A** to **H**).

For details about the editing parameters for each type of effect, see "18 - Appendix" (page 102).

The library data can also be used for other songs.

Even when the parameters are not stored in the library data, the effect assignments and parameters are always stored as part of a song.

## Dynamic effects

When you press the **DYNAMICS** button, the effect inserted in the last selected input (**INPUT A** to **H**) is displayed.

You can select one of the four types of effects (COMPRESSOR, NOISE SUPPRESSOR, DE-ESSER, EXCITER) and apply it to all inputs (**INPUT A** to **H**) (though the simultaneous application has some limitations).

You cannot use multiple types of effects simultaneously.

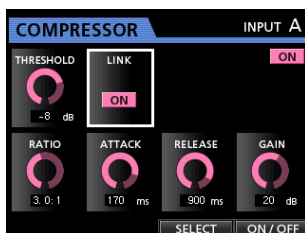

### CAUTION

When using a guitar effect together with a dynamic effect, the dynamic effect can be only inserted into a maximum of 2 channels.

The selected input is displayed on the screen. (**INPUT A** to **H**)  
The on/off state is also displayed on the screen.

## Inserting a dynamic effect

Press the **DYNAMICS** button to open the **DYNAMICS** screen. Press the **SOURCE** button to select the input (**INPUT A** to **H**) into which you want to insert the dynamic effect.

Press the **F3** (**SELECT**) button to select the effect that you want to insert. Press the **F4** (**ON/OFF**) button to set the selected effect to **ON** and insert it.

You can also align the cursor with **INSERT EFFECT** on the Mixer screen and use the **JOG/DATA** dial to turn the effect on/off.

## Editing a dynamic effect

You can edit the parameters of the selected dynamic effect. The editing parameters differ depending on the effect type.

Use the **CURSOR** (**▲/▼/◀/▶**) buttons to select the parameter that you want to change, and then use the **JOG/DATA** dial to select the value.

### NOTE

There is no preset or storage functions available.

## Guitar effects

This unit has multi-effects for guitar. You can insert these effects into the tracks for use.



## Inserting a guitar effect

Press the **EFFECT** button to open the **GUITAR EFFECT/SEND EFFECT** screen (the last displayed effect appears).

When the **SEND EFFECT** screen is displayed, press the **F1** (**GUITAR**) button to open the **GUITAR EFFECT** screen.

If there is any effect already inserted in a track, the **SELECT** button is lit and the track number appears on the upper right corner of the screen.

If there is no effect inserted, the **SELECT** button is unlit, and **TRACK --** appears on the upper right corner of the screen.

Press the **SELECT** button of the track which you want to insert the effect into, and the effect will be inserted.

You can also align the cursor with **INSERT EFFECT** on the Mixer screen and use the **JOG/DATA** dial to turn the effect on/off.

### CAUTION

Guitar effects can be also inserted into stereo tracks. When inserting into a stereo track, though the stereo effect can be achieved depending on the effect used, since the input is monaural and the output is monaural/stereo, observe the following precautions.

- Since the effect input is monaural, when it is inserted into a stereo track, the odd numbered track input becomes active. Therefore, if you want to achieve the stereo effect when recording a stereo track inserted with an effect, set the input assignment to monaural.  
Example: assigning H/H to 13/14 tracks

## Editing guitar effects

You can edit the parameters of the selected guitar effect. The editing parameters differ depending on the effect type.

Press the **F3 (SELECT)** button to select the effect that you want to edit.

Use the **CURSOR (▲/▼/◀/▶)** buttons to select the parameter that you want to change, and then use the **JOG/DATA** dial to select the value.

Select whether you apply the effect during recording or during playback with the **POSITION** parameter on the Guitar Effect screen.

## Calling effects from the guitar effect library

1. On the Guitar Effect screen, press the **F2 (LIBRARY)** button to display the library list.
2. Use the **JOG/DATA** dial to select the effect setting that you want to call, and then press the **F4 (▶)** button.
3. The setting is called and the display returns to the Guitar Effect screen.

Press the **F1 (◀)** button to return to the Guitar Effect screen without changing the parameter.

### NOTE

The preset data is stored in **PRESET**, and the user settings are stored in **USER**.

## Saving guitar effects in the library

You can save an edited setting as a user setting in the library.

1. When the Guitar Effect screen is displayed, press the **F2 (LIBRARY)** button to display the **PRESET/USER** library list.

Use the **JOG/DATA** dial to select the **USER** area, and then press the **F3 (SAVE)** button.

### NOTE

The library list contains a **PRESET** area and a **USER** area. **PRESET** area data cannot be overwritten.

2. Enter a name, if necessary.

Names of the **PRESET** library cannot be changed.

## Send effects

The send effects can be used to send signals to Send Effect 1.

You can select one among the 3 types of send effects (**REVERB**, **DELAY**, **CHORUS**) available. You cannot use multiple types of effects simultaneously.

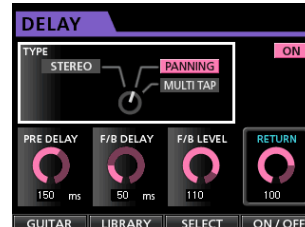

## Using send effects

You can send input channel or track signals to the send effects. Channel signal send levels and pre/post selection are performed on the Mixer screen. (See "Built-in Send Effects and External Effects" on page 47.)

The return from this effect is sent to the stereo bus. In Bounce mode, however, it is sent to the bounce bus. (See "Bouncing tracks" on page 53.)

## Editing send effects

The parameter editing is performed on the **EFFECT** screen.

Press the **EFFECT** button to open the **EFFECT** screen, and while the Guitar Effect is displayed, press the **F1 (SEND)** button to switch to the Send Effect screen.

Press the **F3 (SELECT)** button to select the effect type (**REVERB**, **DELAY**, **CHORUS**).

Use the **CURSOR (▲/▼/◀/▶)** buttons to select the parameter that you want to change, and then use the **JOG/DATA** dial to select the value.

## 9 - Using Built-In Effects

---

### Calling the send effect library

1. On the Send Effect screen, press the **F2 (LIBRARY)** button to display the library list.
2. Use the **JOG/DATA** dial to select the effect setting that you want to call, and then press the **F4 (▶)** button.
3. The setting is called and the display returns to the Send Effect screen.

Press the **F1 (◀)** button to return to the Send Effect screen without changing the parameter.

---

### Saving send effects in the library

You can save an edited setting as a user setting in the library.

1. When the Send Effect screen is displayed, press the **F2 (LIBRARY)** button to display the **PRESET/USER** library list.

Use the **JOG/DATA** dial to select the **USER** area, and then press the **F3 (SAVE)** button.

#### **NOTE**

The library list contains a **PRESET** area and a **USER** area. **PRESET** area data cannot be overwritten.

2. **Enter a name if necessary.**

Names of the **PRESET** library cannot be changed.





# 10 - Mixing Down and Mastering Tracks

## Mixing down tracks

Mixing down tracks is the process of adjusting the volumes and stereo positions of each recorded track and mixing them into a well-balanced stereo track.

Including recorded tracks (24 maximum) and inputs (8 maximum), you can mix down up to 32 tracks in total.

## Levels and balance

Use the **TRACK 1 to 23/24** faders to adjust the relative balance of the tracks.

Then use the **STEREO** fader to adjust the overall level. Watching the stereo level meters on the display, adjust the level until it is suitable.

If the volume is too loud, the sound will be distorted.

### NOTE

The track meters on the display show the recorded signal levels of the tracks. Therefore, these meters do not change when the **TRACK** faders are adjusted.

### TIP

You do not need to keep the entire song at the same volume. For example, you could gradually increase the volume during a guitar solo.

## Fader group

You can control multiple faders simultaneously.

Set or release a group while the **GROUP** button is lit.

### ■ Setting a group

1. Press the **GROUP** button.
2. Adjust the level and balance between tracks you want to control.
3. Press the **SELECT** buttons of tracks to control.

The lit **SELECT** button indicates a track with a group set.

The track fader with the smallest number will be the master fader, and faders with a group set can be controlled. While a fader other than the master fader is operated, the **SELECT** button of the master fader blinks.

This fader group retains the relative level difference from the master fader at the time of setting internally in dB. The physical fader interval is not retained.

### NOTE

When a group has been set, it will not be cancelled even if you press the **GROUP** button. (The **GROUP** button blinks.)

In this case, if the master fader is operated, the **SELECT** buttons of tracks with a group set light during operation.

If another fader is operated, the **SELECT** button of the master fader blinks during operation.

### ■ Releasing a group

1. Press and turn off all the **SELECT** buttons of tracks with a group set.
2. Press the **GROUP** button.

If you press the **GROUP** button before turning off all the buttons (there is still a lit button), the **GROUP** button blinks to indicate that the group setting is active.

### CAUTION

After canceling the group setting, the positions of the physical faders and the actual fader levels (internal fader) may not match. In such a case, when you move a physical fader, the internal fader matches the physical fader value, and thereafter the physical fader controls the level. In this case, a sudden level change may occur.

### NOTE

After setting a group, if it is released or added to and the master fader is changed, the track level is reset to the physical fader value.

## Stereo position (panning)

Use the **PAN** knobs on the Mixer screen of each track to set the stereo position of the track signal.

## TRACK EQ (equalizer)

Each track has a 3-band equalizer.

The equalizer setting is made on the Mixer screen (**TRACK 1** to **TRACK 23/24**).

For a stereo track, the adjustment is the balance (BAL).

1. Press the **MIXER** button to open the Mixer screen.



2. Set the Track EQ (equalizer).

The equalizer parameters are as follows.

	GAIN	FREQ
<b>HIGH</b>	High gain Setting range: $\pm 12$ dB (Default: 0dB)	High frequency Setting range: 1.7kHz to 18kHz (Default: 10kHz)
<b>MID</b>	Mid gain Setting range: $\pm 12$ dB (Default: 0dB)	Mid frequency Setting range: 32Hz to 18kHz (Default: 1.0kHz)
<b>LOW</b>	Low gain Setting range: $\pm 12$ dB (Default: 0dB)	Low frequency Setting range: 32Hz to 1.6kHz (Default: 100Hz)

Use the **SELECT** button of each track to select the desired track.

# 10 - Mixing Down and Mastering Tracks

Use the **HIGH**, **MID**, and **LOW GAIN** knobs to adjust the gain.

Use the **HIGH**, **MID**, and **LOW FREQ** knobs to adjust the center frequency.

Use the **MID Q** knob to set the **MID FREQ** bandwidth.

**Setting range:** 0.25 to 16 (Default: 0.5)

Press the **ON/OFF** button under the **Q** knob to turn the equalizer on or off.

Press the **SOURCE** buttons of **INPUT A** to **H** to set the INPUT EQ (equalizer). (See "Using EQ (equalizer)" on page 46.)

3. After making the settings, press the **HOME** button to return to the Home screen.

## Send effects

This unit has 3 types of send effects.

Adjust the level of the signal sent to the effect from each track by using their **SEND EFF 1/EFF 2** knobs.

### NOTE

The return level from the send effect (**RETURN LEVEL**) can be adjusted on the Send Effect screen.

1. Press the **EFFECT** button to open the Effect screen.



2. Set the send effect.

Press the **EFFECT** button to open the Effect screen where the last operation was performed. Press the **F3** (**SELECT**) button to select one from the 3 available types (**REVERB**, **DELAY**, **CHORUS**). You cannot use multiple types of effects simultaneously.

Align the cursor with the parameter that you want to select, and then use the **JOG/DATA** dial to set the parameter.

The return from the send effect is mixed with the stereo signal.

3. After making the send effect setting, press the **HOME** button to return to the Home screen.
4. Use the **SEND EFF 1** knob to adjust the level of the signal sent to the send effect of each track.

### TIP

When using an external effect, connect the output of the external effect (return) to **INPUT A** to **H**. By assigning the connected input to the stereo bus, you can return the effect sound to the stereo bus. (See "Assigning to a stereo bus" on page 44.)

## Creating a master file

When you are satisfied with your mix, this unit can record the mixed down tracks and create a master file.

A master file recorded by this unit is saved as part of the song.

This master file can be recorded by an external stereo recorder, and can also be converted by the unit into a WAV file and stored with the same name of a song in the song folder of the SD card.

### NOTE

Only one master file (song name ".wav") can be created inside a song (when mastering, there is another file besides the master file (song name ".wav"), but it is a file for internal use).

## Setting the start and end points

Before creating a master file, set the start and end points of the mixed down master file. The range between the song's **IN** point and **OUT** point will be recorded as the master file.

Ordinarily, set the beginning of the song as the **IN** point and the end of the song as **OUT** point.

Press and hold the **MARK SET** button and press the **IN** button where you want to set the **IN** point (start point) of the master file, and press and hold the **MARK SET** button and press the **OUT** button where you want to set the **OUT** point (end point).

For more information about how to correct the **IN/OUT** points, see "Setting **IN/OUT** points" on page 56.

# 10 - Mixing Down and Mastering Tracks

## Creating a master file

After setting the IN and OUT points, you are ready to create the master file.

1. **When Recorder mode is Multi Track mode, press the MIXDOWN/MASTERING button.**

The Recorder mode switches to Mixdown mode and the display returns to the Home screen.

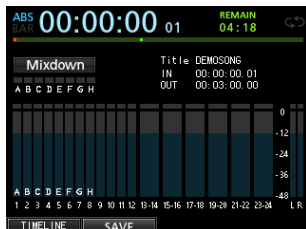

If you play or record, you can hear the signal of the mixed tracks (the signal to be recorded) through headphones or monitoring system.

### NOTE

- In Mixdown mode, Mixdown appears on the upper left corner of the Home screen.
  - If the interval between the IN and OUT points is shorter than 4 seconds, when you start the record, Trk Too Short appears and the mixdown recording cannot be performed.
  - When Recorder mode is Mixdown mode, some playback functions do not work. If you try to use one of these functions, In Mixdown Mode appears.
2. **Press the RECORD (●) button.**

The mixdown starts and the RECORD (●) button becomes lit.

Regardless of the recorder's current position, the mixdown starts from the IN point.

If necessary, use the track faders or the Mixer screen's PAN knobs to mix down the tracks to stereo. These adjustments will be reflected in the master file.

When the recorder reaches the OUT point, recording automatically stops.

3. **If you want to redo the creation of the stereo master track, press the RECORD (●) button.**

A new master file will be created, and the previous master file will be overwritten.

### NOTE

After recording the master file, you can play back the master file to check it. (See "Checking the master file" on the right column.)

## Exiting Mixdown mode

Press the MIXDOWN/MASTERING button twice to return to Multi Track mode of the Recorder mode.

## Checking the master file

Follow the procedure below to listen to a master file after you have completed recording it.

1. **When Recorder mode is Mixdown mode, press the MIXDOWN/MASTERING button.**

The Recorder mode switches to Mastering mode and the display returns to the Mastering screen.

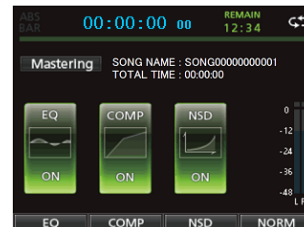

### NOTE

- In Mastering mode, Mastering appears on the upper left corner of the Home screen.
  - When Recorder mode is Multi Track, press the MIXDOWN/MASTERING button to switch to Mixdown mode, and then press the MIXDOWN/MASTERING button again to switch to Mastering mode.
  - You cannot switch to Mastering mode if there is no master file.
2. **In this state, press the PLAY (▶) button to play back the master file that you have created.**

### CAUTION

Confirm that both the EQ and COMP items are set to OFF. If either is set to ON, the sound will be affected by the equalizer and/or compressor. (See "Using the mastering EQ (equalizer)" on page 71 and "Using mastering compression" on page 72.)

3. **When Recorder mode is Mastering mode, the transport buttons work as follows.**

- Press the PLAY (▶) button to play back the master file from the current position until its end.
- Use the REW (◀◀) (TO ZERO) button and the F FWD (▶▶) (TO LAST REC) button to perform rewind/fast-forward in the same way as in ordinary Recorder mode.
- Press the STOP (■) button to stop playback.
- Track recording is not possible.
- Repeat playback and location mark functions cannot be used.

Since the master file playback signal is output from the STEREO OUT jack, you can record the output to an external stereo recorder.

If you are not satisfied with the created master file, you can perform a new mixdown.

# 10 - Mixing Down and Mastering Tracks

## NOTE

To listen to a master file recorded in a saved song, load the song, change the Recorder mode to **Mastering** mode, and then press the **PLAY (▶)** button to start playback.

## Ending master file checking

After checking the master file, press the **MIXDOWN/MASTERING** button to return to the **Multi Track** mode of the Recorder mode.

## Finishing up a master file (mastering)

This unit has specialized tools for mastering the master file. Use the equalizer, noise shaper, compressor, and normalize function to adjust the overall volume and sound quality.

Change the Recorder mode to **Mastering** mode and use the mastering tools to finish up (master) the master file.

## Mastering procedures

Follow the steps below to perform mastering.

### ■ Step 1 - Enter Mastering mode.

When Recorder mode is **Mixdown** mode, press the **MIXDOWN/MASTERING** button.

The Recorder mode switches to **Mastering** mode and the **Mastering** screen is displayed.

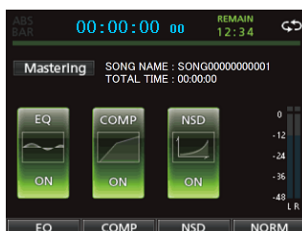

## NOTE

- When Recorder mode is **Multi Track** mode, press the **MIXDOWN/MASTERING** button to switch to **Mixdown** mode, and then press the **MIXDOWN/MASTERING** button again to switch to **Mastering** mode.
- You cannot switch to **Mastering** mode if there is no master file.

### ■ Step 2 - Use the mastering tools to adjust the sound.

You can use the following functions as mastering tools: **EQUALIZER** function (**F1 (EQ)** button), **COMPRESSOR** function (**F2 (COMP)** button), **NOISE SHAPED DITHERING** function (**F3 (NSD)** button), and **NORMALIZE** function (**F4 (NORM)** button).

You also can choose between a multi-band and single-band type compressor on the **COMP MULTI** screen by pressing the **F2 (SINGLE)** or **F2 (MULTI)** button.

For the multi-band compressor, the parameter setting display of the **COMP MULTI** screen is split into **LOW BAND**, **MID BAND** and **HIGH BAND** areas for individual low, mid and high frequency adjustments.

Make the necessary settings in each tool screen. (For further details, see the following "Using the mastering EQ (equalizer)," "Using mastering compression," "Using normalize," and "Using the noise shaper (Noise Shaped Dithering)")

When Recorder mode is **Mastering** mode, since you can use the **PLAY (▶)**, **STOP (■)**, **REW (◀◀) (TO ZERO)**, and **F FWD (▶▶) (TO LAST REC)** transport buttons, adjust the settings as you monitor the playback signal.

### ■ Step 3 - Perform the recording.

After adjusting the settings of the mastering tools, press the **RECORD (●)** button to start recording.

The recording starts and the **PLAY (▶)** and **RECORD (●)** buttons become lit.

Recording always starts from **00:00:00:00** regardless of the current position.

Recording in **Mastering** mode overwrites the master file.

At the end of the master file, recording finishes automatically and the position returns to **00:00:00:00**.

## NOTE

If you stop recording in the middle, a master file will be created until the time when you stopped the unit.

### ■ Step 4 - Check your recording.

Turn the equalizer and compressor off before playing back the master file to check the mastering results.

Single undo and redo can be used, so you can compare the sound before and after mastering.

### ■ When you are not satisfied with the result

Undo the operation to return master file to mixdown state, and perform the mixdown again from step 1.

## NOTE

Multi-undo and redo cannot be used when the Recorder mode is **Mastering** mode.

## Using the mastering EQ (equalizer)

1. When the **Mastering** screen is displayed, press the **F1 (EQ)** button to open the **EQUALIZER** screen.

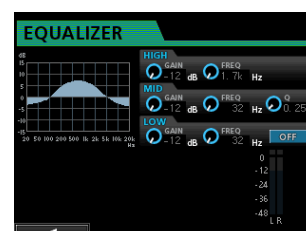

Mastering equalization is set on this screen.

# 10 - Mixing Down and Mastering Tracks

## 2. Set the mastering equalization on this screen.

The equalizer parameters are as follows.

	GAIN	FREQ
<b>HIGH</b>	High gain Setting range: $\pm 12$ dB (Default: 0dB)	High frequency Setting range: 1.7kHz to 18kHz (Default: 10kHz)
<b>MID</b>	Mid gain Setting range: $\pm 12$ dB (Default: 0dB)	Mid frequency Setting range: 32Hz to 18kHz (Default: 1.0kHz)
<b>LOW</b>	Low gain Setting range: $\pm 12$ dB (Default: 0dB)	Low frequency Setting range: 32Hz to 1.6kHz (Default: 100Hz)

Use the **HIGH**, **MID**, and **LOW GAIN** knobs to adjust the gain.

Use the **HIGH**, **MID**, and **LOW FREQ** knobs to adjust the center frequency.

Use the **MID Q** knob to set the **MID FREQ** bandwidth.

**Setting range:** 0.25 to 16 (Default: 0.5)

You use the **EQUALIZER ON/OFF** button to turn the equalizer on/off.

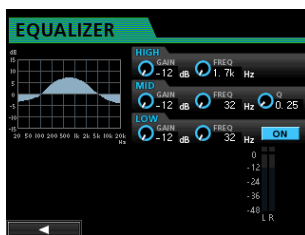

### NOTE

**Q** refers to the center frequency of the equalizer divided by the bandwidth. A high **Q** value reduces the cut and/or boost applied to the frequencies. Depending on the equalizer settings, the graph at the top of the screen changes.

3. After making the settings, press the **F1** (**◀**) button to return to the Mastering screen.

4. The **EQ** item state of the Mastering screen is shown as **ON** or **OFF**.

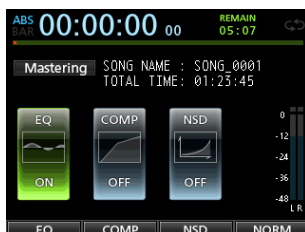

## Using mastering compression

You can choose between a single band and a multi-band type of compressor.

Multi-band compressors allow independent settings for the low, mid and high frequency ranges, so you can adjust the overall volume balance. By using compression, you can also reduce unwanted peaks and increase the overall gain in order to raise the volume, creating a mastered sound with greater impact.

1. When the Mastering screen is displayed, press the **F2 (COMP)** button to open the **COMP MULTI** screen.



2. Press the **F3 (LIBRARY)** button to open the library list pop-up screen.

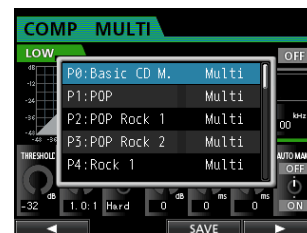

3. Use the **JOG/DATA** dial or the **CURSOR** (**▲/▼**) buttons to select (blue highlight) the desired library, and then press the **F4 (▶)** button.

After the library is read, the display returns to the **COMP MULTI** screen.

4. When using the multi-band compressor, move the cursor to the band display area, use the **JOG/DATA** dial to switch among the bands, and then set the parameter for each band as desired.



Multiband type



Single band type



# 10 - Mixing Down and Mastering Tracks

At this time, the selected band is shown in the upper left corner.

5. Use the **CURSOR** (▲/▼/◀/▶) buttons to select the item whose value you to change, and then use the **JOG/DATA** dial to change it.

## THRESHOLD

Set the threshold value that determines when the compressor begins to operate.

## RATIO

Set the compression ratio.

## KNEE

Select the transition curve.

## GAIN

Adjust the output level.

## ATTACK

Adjust the attack time.

## RELEASE

Adjust the release time.

## AUTO MAKE

This feature automatically adjusts the volume to prevent it from being reduced by the compressor.

6. When using the multi-band type, move the cursor to **CROSSOVER** and then use the **JOG/DATA** dial to adjust the frequency range of each band.



7. Press the **F4 (ON/OFF)** button to turn the compressor on or off. The ON or OFF state is shown on the Mastering screen.
8. After setting the parameters, press the **F1 (◀)** button to return to the Mastering screen.

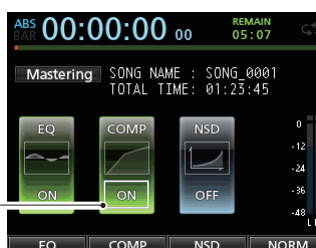

Compressor  
ON/OFF

## Using normalize

Use the normalize function to automatically adjust the volume.

This function detects the highest volume level and raises the overall volume until the highest level reaches the maximum limit.

## CAUTION

If you use equalization or compression after normalizing the track, distortion might occur.

Use the normalize function after adjusting the sound quality with equalization and compression.

1. When the Mastering screen is displayed, press the **F4 (NORM)** button to open the **NORMALIZE** screen.

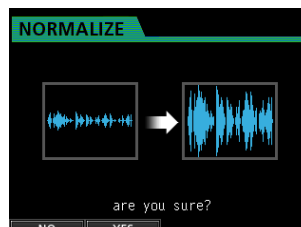

2. Press the **F2 (YES)** button to perform the normalization.
3. Once the normalization is completed, the display returns to the Mastering screen.

## Using the noise shaper (Noise Shaped Dithering)

### ■ What is noise shaper

Audio CDs use 16-bit quantization, so the master file data is automatically converted to 16-bit.

In general, bit conversion results in a very low level of quantization distortion at points where sound is removed, but you can reduce this quantization distortion by turning the noise shaper on.

The noise shaper in this unit uses a dithering technique that adds random noise below the quantization steps to reduce quantization distortion.

1. When the Mastering screen is displayed, press the **F3 (NSD)** button to open the **NOISE SHAPED DITHERING** screen.

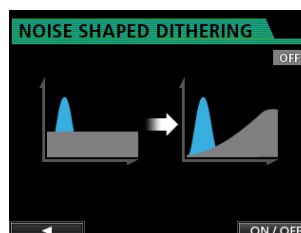

2. Press the **F4 (ON/OFF)** button to set the noise shaper function to ON.
3. Press the **F1 (◀)** button to return to the Mastering screen.

## Exiting Mastering mode

To exit Mastering mode and return to Multi Track mode, press the **MIXDOWN/MASTERING** button.

# 11 - Various Other Functions

## Metronome

This unit has a built-in metronome.

The metronome works during the Recorder operation.

You can set it to work during both playback and recording or only during recording.

1. **When the Recorder is stopped, press the METRONOME button to open the METRONOME screen.**

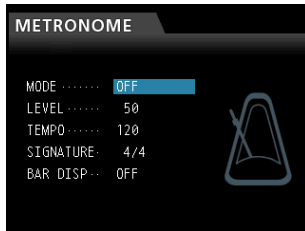

2. **Set the following items.**

Use the **CURSOR** ( $\blacktriangle$  /  $\blacktriangledown$ ) buttons to select the desired item, and then use the **JOG/DATA** dial to change its value.

### MODE

You can select from the following modes.

Mode	Description
OFF	Default, metronome OFF
REC&PLAY	Works both during recording and playback
REC	Works only during recording

### TEMPO

Set the speed.

The setting range is from 20 to 250 (BPM).  
(Default: 120)

### SIGNATURE

Set time signature to 4/4, 3/4, etc.

The setting range is from 1/1 to 12/8. (Default: 4/4)

### BAR DISP

Set the **BAR** display to ON/OFF. (Default: OFF)

### LEVEL

Set the metronome volume.

The setting range is from 0 to 127. (Default: 100)

3. **After making the settings, press the HOME button to return to the Home screen.**

The metronome works according to the **MODE** setting made in step 2 above.

When the setting is enabled, the **METRONOME** button flashes according to the metronome tempo.

The metronome signal is not recorded even if set to work during recording.

### NOTE

- When the metronome is working, you can monitor the sound of the metronome through connected external speakers. Note, however, that the metronome sound might also be recorded when you use a microphone to record.
- When the metronome is working, you can adjust the **LEVEL** item on the **METRONOME** setting screen, but other items cannot be changed.
- You can use the metronome as a click track to help keep time when recording rhythm guitar, bass, etc. at the beginning of a song.
- If you want to use the metronome for practice, you can either turn each track's fader all the way down during playback or play a song that does not have any recordings.

## MIDI Sync

This unit support MIDI Time Code (MTC) and MIDI Clock, so synchronization with other equipment is possible.

The following synchronization types are available.

### ■ MTC Master

You can synchronize the MTC generated by this unit with an external equipment (MTC compatible synthesizer, DAW, etc.).

### ■ MIDI Clock Master

You can synchronize an external equipment (sequencer, drum machine, etc.) with the MIDI clock based on a specified tempo.

### NOTE

When MIDI clock master is selected, besides the MIDI clock, a variety of information such as start, stop, continue, or song position points can be transmitted from this unit to another device. When MTC master is selected, full time code messages can be transmitted while locating the song position.

The synchronization settings are made under the **SYNC** item on the **MIDI** screen.

### ■ FRAME TYPE

The MTC format used for transmission/reception is only 30 (music, High-Vision).

### ■ GENERATOR

Select a sync signal emitted through the MIDI OUT jack.

- To set this unit to MTC Master, select **MTC**.
- To set this unit to MIDI Clock Master, select **CLOCK**.
- When you do not want to output a sync signal from the unit, select **OFF**.



## MIDI remote control

The mixer, effects and recorder of this unit can be remotely controlled by external devices through MIDI messages.

For more information about the MIDI messages that control this unit, see "18 - Appendix" on page 101.

When the transport is stopped, press the **MENU** button to open the **MENU** screen, select (blue highlight) the **MIDI** menu item, and then press the **F4 (▶)** button.

The **MIDI** screen appears.

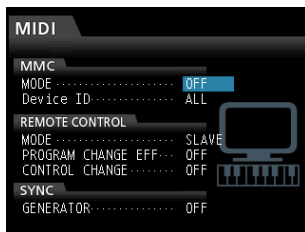

### ■ MMC MODE

Set transmission/reception mode of the MMC (MIDI Machine Control).

OFF: MMC communication is not performed.

MASTER: This unit functions as the MMC master.

SLAVE: This unit functions as the MMC slave.

When the unit is the MMC master, the MMC command is output by the **MIDI OUT** jack, and it is possible to remotely control an external MIDI sequencer or another DP-24 unit.

When the unit is the MMC slave, the MMC command is input into the **MIDI IN** jack, and it is possible to remotely control this unit from an external MIDI sequencer or another DP-24 unit.

### ■ MMC Device ID

Set the MMC device ID.

Select from 1 to 127, and ALL. (Default: ALL)

MMC commands are sent and received between master and slaves with the same device IDs, but when ALL is selected, MMC commands are sent and received for all IDs.

MMC is used for remote transport control of MIDI equipment. On the other hand, MTC (MIDI Time Code) for synchronization with MIDI equipment. Note that the MMC mode and MMC device ID are not related to mixer and effect remote control.

### ■ REMOTE CONTROL

With **MODE**, set this unit as a master or slave.

With **PROGRAM CHANGE EFF**, received program change messages control this unit's effect switchover (ON or OFF). In Mastering mode, program change messages are not transmitted even if the effect switchover is turned on.

With **CONTROL CHANGE**, received control change messages control this unit's mixer parameters and effect parameters (ON or OFF).

## Tuner function

You can use the built-in chromatic tuner to tune guitars.

1. **Connect the guitar or bass guitar to the MIC/LINE INPUTS H jack.**

Tuning cannot be performed on instruments connected to the **MIC/LINE INPUTS A** to **G** jacks.

2. **Set the LINE-GUITAR switch on the rear panel to GUITAR . (See "Selecting the input sources" on page 44.)**
3. **When the recorder is stopped, press the MENU button to open the MENU screen.**
4. **Use the JOG/DATA dial to select the TUNER menu item and then press the F4 (▶) button.**

The **TUNER** screen appears.

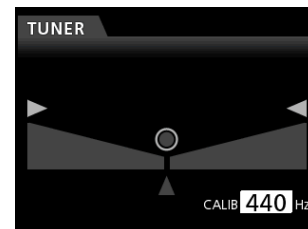

5. **Use the JOG/DATA dial or the CURSOR (▲/▼) buttons to set the A4 (La) standard frequency.**

The setting range is from 435Hz to 445Hz. (Default: 440Hz)

6. **Play the instrument and begin tuning.**

The pitch name closest to the string appears above the meters.

Tune the instrument so that the target pitch name appears and the center of the tuning meter lights.

A bar appears on the left or right of the center if the sound is lower or higher than the target pitch. The bar becomes longer as the sound shifts away from the target pitch.

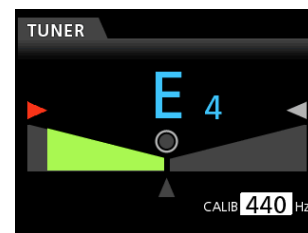

When the pitch played matches the note shown, the center "◎", "▶" and "◀" lights green.

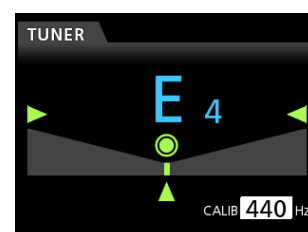

# 11 - Various Other Functions

7. After tuning the instrument, press the HOME button to return to the Home screen.

**NOTE**

The following buttons can be controlled in the Tuner mode.

- INPUT TRIM (Analog)
- JOG/DATA dial (Calibration)
- Monitor level

---

## Setup (PREFERENCE)

---

You can use the PREFERENCE screen to change various settings to optimize the unit for your use environment and other requirements, as well as to restore the factory settings.

The PREFERENCE menu allows you to customize the unit to your preference.

Follow the procedure below to open the PREFERENCE screen.

1. When the recorder is stopped, press the MENU button to open the MENU screen.
2. Use the JOG/DATA dial or the CURSOR (▲/▼/◀/▶) buttons to select PREFERENCE, and then press the F4 (▶) button.



The PREFERENCE screen appears.

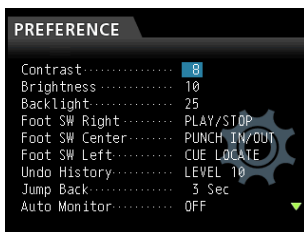

3. On the PREFERENCE screen, use the CURSOR (▲/▼) buttons to select a parameter, and then use the JOG/DATA dial to change its setting.
  - Contrast (LCD adjustment)
  - Brightness (LCD adjustment)
  - Backlight (LCD adjustment)
  - Foot SW Right (Foot switch R assignment)
  - Foot SW Center (Foot switch C assignment)
  - Foot SW Left (Foot switch L assignment)
  - Undo History (Switch over between level 1 and level 10)
  - Jump Back (Jump time setting)

- Auto Monitor (Auto Monitor setting)
- Preview Time (Preview time setting)
- Song Name Type (Switching between DATE and WORD)
- Date/Time (System time/date setting)
- Initialize (Factory setting reset)

---

## Auto Monitor

When stopped and the Recorder function is enabled, the input monitoring becomes possible.

The Auto Monitor starts playback, mutes the input sound, and provides the monitoring of the playback sound only.

**OFF (Default):**

Even when the playback starts, the input sound is not muted.

When the Recorder function is ON, the input sound and the playback sound are mixed.

**ON:**

When the playback starts, the input sound is muted.

When the Recorder function is ON, only playback sound is heard.

## Restoring the initial preference settings

You can restore the PREFERENCE screen settings to the initial adjustments (factory default settings). This operation is called initialization.

1. When the recorder is stopped, press the MENU button to open the MENU screen.
2. Use the JOG/DATA dial or the CURSOR (▲/▼/◀/▶) buttons to select (green highlight) PREFERENCE, and then press the F4 (▶) button.



The PREFERENCE screen appears.

3. Use the CURSOR (▲/▼) buttons to select Initialize, and then press the F4 (▶) button.

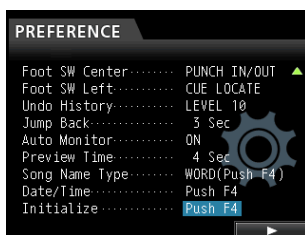

4. As a confirmation message appears, press the F2 (YES) button to confirm.

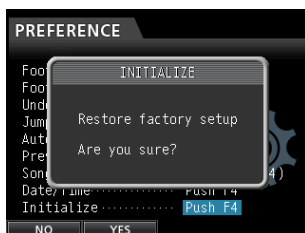

5. Once the initialization is completed, the display returns to the PREFERENCE screen.

### NOTE

If you want to cancel the initialization, press the F1 (NO) button.

6. After making the settings, press the HOME button to return to the Home screen.

## Viewing information

You can view information about the current song (currently loaded song), the SD card and the firmware.

1. When the recorder is stopped, press the MENU button to open the MENU screen.
2. Use the JOG/DATA dial or the CURSOR (▲/▼/◀/▶) buttons to select (green highlight) INFORMATION, and then press the F4 (▶) button.



The INFORMATION screen appears.

The following information is displayed on the INFORMATION screen.

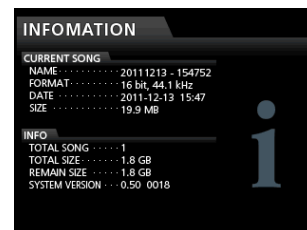

### CURRENT SONG

NAME  
FORMAT  
DATE  
SIZE

### INFO

TOTAL SONG  
TOTAL SIZE  
REMAIN SIZE  
SYSTEM VERSION

# 12 - SD Card Management

The recording files are stored on the SD cards.

Depending on the SD card capacity, the card is formatted with the FAT16 or FAT32 file system.

SD card capacity	File system
512MB to 2GB	FAT16
Above 2GB	FAT32

Moreover, this unit is compatible with SD card write protect function, so you can write-protect your cards to prevent accidental deletions by formatting them. (See "About write-protected SD cards" on page 34.)

When an SD card is inserted, the unit performs a mounting process and then enables the SD card use. At this time, if the inserted SD card has not been formatted by this unit, a message appears prompting you to format it.

If the inserted SD card has no setup files stored in it, a message appears prompting you to create a setup file.

When an SD card is ejected, the unit performs an unmount process and then a No Card message appears.

## CAUTION

- The ejection during recording is not supported.
- The format operation cannot be undone.

## NOTE

- The FAT (File Allocation Table) format is a disk format that can be read by a computer.
- SD and SDHC cards that are at least 512MB in size can be used.

A list of SD cards that have been confirmed to work with this unit can be found on TASCAM website (<http://tascam.com/>).

## Quick formatting an SD card

Use the QUICK FORMAT item to quickly format an SD card. Using QUICK FORMAT erases all files on the card and automatically creates new MUSIC, UTILITY, and AudioDepot folders, as well as the dp-24.sys file that is necessary to use the SD card with this unit.

## CAUTION

This operation erases all the data from the SD card. This operation cannot be undone.

Confirm that you will not lose important data before quick formatting a card.

1. **When the recorder is stopped, press the MENU button to open the MENU screen.**
2. **Use the JOG/DATA dial or the CURSOR (▲/▼/◀/▶) buttons to select (green highlight) FORMAT, and then press the F4 (▶) button.**



The Quick Format/Full Format selection screen appears.

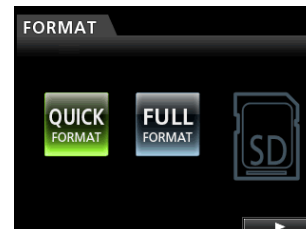

3. **Use the JOG/DATA dial to select QUICK FORMAT and press the F4 (▶) button.**

A confirmation message (QUICK FORMAT) appears.

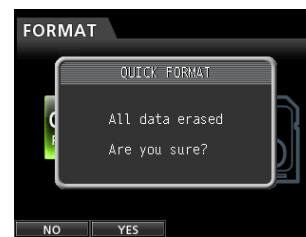

4. **Press the F2 (YES) button to execute the quick format. If you want to cancel the quick format, press the F1 (NO) button.**
5. **Once the quick format is completed, the display returns to the FORMAT screen.**

## NOTE

When a card is formatted, a song is automatically created in the MUSIC folder.

## Full formatting an SD card

Use the FULL FORMAT item to full format an SD card. Using FULL FORMAT erases all files on the card and automatically creates new MUSIC, UTILITY, and AudioDepot folders, as well as the dp-24.sys file that is necessary to use the SD card with this unit.

With Full Format, memory errors are checked during the formatting. The full format takes longer than the quick format.

This operation will execute the Full Format of an SD card.

### CAUTION

This operation erases all the data from the SD card. This operation cannot be undone.

Confirm that you will not lose important data before full formatting a card.

1. When the recorder is stopped, press the MENU button to open the MENU screen.
2. Use the JOG/DATA dial or the CURSOR (▲/▼/◀/▶) buttons to select (green highlight) FORMAT, and then press the F4 (▶) button.



The Quick Format/Full Format selection screen appears.



3. Use the JOG/DATA dial to select FULL FORMAT and press the F4 (▶) button.

A confirmation message (FULL FORMAT) appears.



4. Press the F2 (YES) button to execute the full format. If you want to cancel the full format, press the F1 (NO) button.

5. Once the full format is completed, the display returns to the FORMAT menu screen.

### NOTE

When a card is formatted, a song is automatically created in the MUSIC folder.

# 13 - Exchanging Data with a Computer

By connecting this unit to a computer using the included USB cable, you can backup song data from an SD card in the unit to a computer and restore backed-up song information. In addition, you can export track files and stereo master files from songs to the computer, as well as import audio files from the computer to the unit.

Backed up data can be restored to a different DP-24 unit than the one that created it. In other words, files can be freely exchanged between DP-24 units, making it easy to add additional recordings or mix existing recordings in a different location.

## CAUTION

If you want to remove an SD card from this unit and back up its data on a computer using a card reader, always turn off the unit's power before removing the card.

## NOTE

In this chapter, "computer" refers to a Windows or Macintosh personal computer connected to this unit. (See "Operating system requirements" on the right column.)

The following types of data can be transferred from this unit to a computer.

### ■ Entire songs

You can transfer the data for an entire song from the unit's MUSIC folder to a computer. This operation is called "backup". In addition, data backed up on a computer can be transferred to the MUSIC folder, and then restored as song file. This operation is called "restore".

### ■ WAV format tracks

Export specified track files as WAV files to the AudioDepot folder of the SD card. In addition, you can import specified track files by storing WAV files from a computer to the AudioDepot folder beforehand.

In other words, the data transfer between the computer and track files is carried out through the AudioDepot folder.

### ■ Master file

A master file created on this unit can be transferred to a computer as a stereo WAV file (from the "Song name" folder inside the MUSIC folder).

Only export is possible.

## Operating system requirements

You can connect this unit to computers with the following operating systems.

### ■ Windows

Windows XP, Windows Vista, Windows 7

### ■ Mac OS X

Mac OS X 10.2 or later

When this unit is connected to a computer, the computer recognizes it as a removable disk. There is no need for a special driver.

## NOTE

Data transfer between this unit and a computer occurs at USB 2.0 speed (maximum). Data can still be transferred if the computer connection is USB 1.1, but it will be slower. In addition, to assure USB 2.0 speed, use a cable that meets USB 2.0 standards.

## Connecting to a computer

When connected via USB, this unit's record, playback and other recorder operations cannot be used.

To connect with a computer, connect the USB port on the rear panel of the unit with a **USB** port on the computer using a mini-B-type USB 2.0 cable.

It does not matter whether you turn the unit's power ON before or after the USB connection is made.

When this unit is ON, enable the USB connection in the **USB** item of the **MENU** screen.

The currently loaded song is saved before the USB connection becomes effective. When connected, the following screen appears on the display.

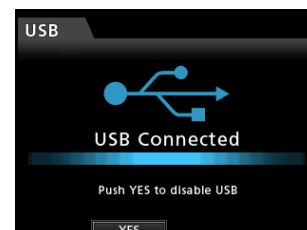

After making a USB connection, you must turn the power on and enable the USB connection in the **USB** item of the **MENU** screen.

This unit appears as an external drive named DP-24 on the computer's display.

Clicking on the DP-24 drive will display the MUSIC, UTILITY, and AudioDepot folders.

## CAUTION

- Be sure to use the included TASCAM PS-1225L AC adapter to supply power to this unit. Power cannot be supplied to this unit via USB.



# 13 - Exchanging Data with a Computer

- Do not disconnect the AC adapter or otherwise cut the power to the unit during data transfer. Doing so will cause all the data to be lost. This lost data cannot be restored.
- Do not change the folder names inside the DP-24.

## NOTE

The UTILITY folder is used to, for example, update the system software used by the unit. In addition, do not change the names or delete individual files contained in the Song folder inside the MUSIC folder. There is no problem if you delete a Song folder as a whole.

## Disconnecting

Follow the procedure below to disconnect the USB connection correctly.

## CAUTION

When transferring data, do not disconnect the unit or remove the USB cable. Doing so could cause data on the computer or this unit to be damaged.

## NOTE

When disconnecting from a computer, the procedure on the computer might be called "eject", "unmount" or "remove".

## ■ In the case of Windows XP/ Windows Vista/ Windows 7

Follow the procedures below to disconnect computers that use Windows XP, Windows Vista, or Windows 7 operating systems.

A PC card icon and arrow appear in the taskbar (usually at the bottom right of the screen).

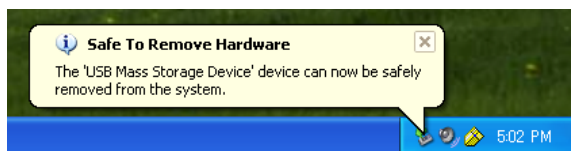

1. Left click on this icon to open a pop-up bar. Click on this pop-up bar to disconnect this unit from the computer.
2. After a message appears on the computer screen saying that this unit can be disconnected, press the applicable function key to disconnect this unit and the computer. After that, you can unplug the USB cable.

The Home screen appears on the display.

## CAUTION

If a message appears on the computer screen saying that this unit cannot be disconnected safely, do not disconnect the USB cable.

Close all the computer programs and windows that are accessing files on this unit, and then try the operation again.

## ■ In the case of Macintosh

1. Drag the DP-24 icon that represents this unit to the Trash, or use Command + E to eject the DP-24.

## TIP

Depending on the OS version or OS settings you might also be able to eject the DP-24 icon by clicking on an eject icon next to it in the Finder window or by using a control key.

2. After the DP-24 icon disappears from the display, press the function key to disconnect this unit and the computer. After that, you can unplug the USB cable.

The Home screen appears on the display.

# 13 - Exchanging Data with a Computer

## Track import and export

You can import and export individual tracks between a computer and this unit's by using the AudioDepot folder.

Files that can be imported/exported as tracks must be WAV files (with the ".WAV" extension).

You can import both mono and stereo files, and export mono files.

If you want to import audio into this unit that is of a different format, you must convert it to a WAV file first.

### Importing tracks

1. **Connect the unit to a computer.** (See "Connecting to a computer" on page 80.)
2. **Operate the computer to copy WAV files to the AudioDepot folder of this unit.**

#### NOTE

The files to be copied must have single-byte alphanumeric character names.

If you try to copy a file named in Japanese characters, as the file name does not appear on the display in step 6 below, it cannot be imported.

3. **Disconnect properly the unit from the computer, and then unplug the USB cable.** (See "Disconnecting" on page 81.)
4. **Press the MENU button to open the MENU screen.**
5. **Use the JOG/DATA dial or the CURSOR (▲/▼/◀/▶) buttons to select (green highlight) AUDIO DEPOT, and then press the F4 (▶) button.**



The WAV files that can be imported appear.

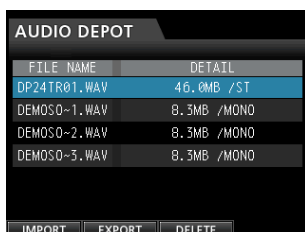

6. **Use the JOG/DATA dial or the CURSOR (▲/▼) buttons to select the WAV file that you want to import, and then press the F1 (IMPORT) button.**

Empty tracks that can be imported appear.

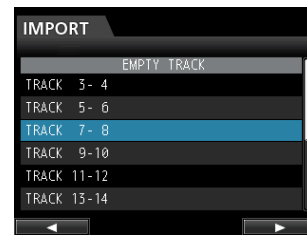

#### NOTE

- If you are trying to import a WAV file whose attribute does not match the current song attribute, an error pop-up message appears. For example, the current song attribute is 44.1 kHz, but you are trying to import a 48 kHz WAV file. When there is no file that can be imported, FILE NOT FOUND appears.
  - When the file name is short, spaces appear after the file name, but those spaces are not included in the actual file name.
7. **Use the JOG/DATA dial or the CURSOR (▲/▼) buttons to select the track to be imported, and then press the F4 (▶) button.**

A confirmation message appears.

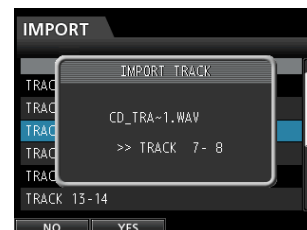

#### NOTE

When the WAV file to be imported is stereo, you must select a track pair.

8. **Press the F2 (YES) button to execute the import.**  
Import starts.

#### NOTE

- If there is no enough space or the file format is wrong, an error message appears.
  - The beginning of the file is set at the start of the song (00:00:00:00). In the same way as other recording tracks, you can edit the track that has received the imported file. (See "Track Editing" on page 60.)
  - To import a stereo WAV file, an empty stereo track is necessary.
9. **Once the import is completed and a pop-up window is displayed, the display returns to the Audio Depot screen.**
  10. **Press the HOME button to return to the Home screen.**

## Exporting tracks

1. When the recorder is stopped, press the MENU button to open the MENU screen.
2. Use the JOG/DATA dial or the CURSOR (▲/▼/◀/▶) buttons to select (green highlight) AUDIO DEPOT, and then press the F4 (▶) button.
3. Press the F2 (EXPORT) button.

The EXPORT screen appears showing a list of tracks that contain stored audio.

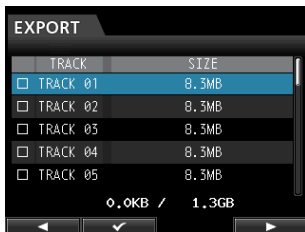

### NOTE

Song tracks that do not have audio recordings are not displayed in the file list.

4. Use the JOG/DATA dial to select (blue highlight) the track that you want to export, and then press the F2 (✓) button.

A check mark ✓ appears in the check box next to the selected track.

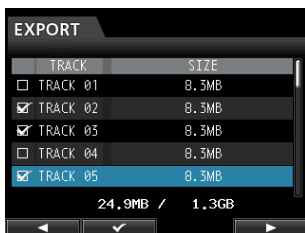

By checking multiple check boxes (✓), you can export more than one track at once.

### NOTE

To remove the check mark ✓ from a check box, press the F2 (✓) button again while the track is selected (blue highlight).

5. When you finish putting checks (✓) next to the tracks that you want to export, press the F4 (▶) button.

A confirmation message appears.



6. Press the F2 (YES) button to export the selected track to the AudioDepot folder.

### NOTE

When a track file with the same name already exists in the AudioDepot folder, a number is added to the file name end, so the track is not overwritten.

7. After the pop-up message appears, the display returns to the Audio Depot screen.
8. Press the HOME button to return to the Home screen.
9. Connect the unit to a computer. (See "Connecting to a computer" on page 80.)
10. Operate the computer to copy track files from the AudioDepot folder of the SD card to the computer.
11. After exporting track files to the computer, disconnect the unit from the computer using the proper procedures, and then unplug the USB cable. (See "Disconnecting" on page 81.)

## Deleting files from the AudioDepot folder

1. When the file list is displayed, use the JOG/DATA dial or the CURSOR (▲/▼) buttons to select the files that you want to delete.
2. Press the F3 (DELETE) button, which will cause a confirmation message to appear.



3. Press the F2 (YES) button to execute the deletion.
- When you want to delete multiple files, repeat the procedure above.

# 14 - Using CDs

## Using the CD drive

This unit has a CD drive that supports writing to CD-R and CD-RW discs. In addition to playing back Audio CDs (CD-DA), the unit's CD drive can also be used for the following purposes.

- Create an Audio CD from the master file.
- Import tracks from Audio CDs into the current song.

### CAUTION

When creating a CD from a master file, set to 44.1kHz, 16bit to create a song.

## Preparations before using CDs with this unit

When using CDs with this unit, make the following preparations.

- Before using a CD, change the recorder mode to **Multi Track**. In modes other than **Multi Track**, you cannot open the CD menu screen. In **Mixdown** or **Mastering** mode, press the **MIXDOWN/MASTERING** button repeatedly until the unit switches to **Multi Track** mode. In **Bounce** mode, press the **BOUNCE** button to switch to the **Multi Track** mode.
- Open the **CD** menu screen before inserting or ejecting a CD.

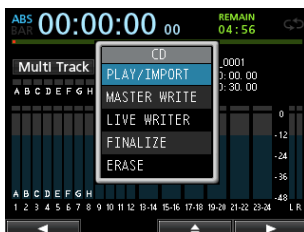

In order to prevent the sound of the CD drive being operated during recording, for example, the power to the drive is disabled when in modes other than CD mode. For this reason, it is necessary to put the unit into CD mode in order to load or eject a CD. Even in CD mode, a CD cannot be loaded or ejected after being mounted. (Except for CD menu screen)

Since CD mounting is canceled in screens other than CD menu screen, load or eject a CD in the CD menu screen or CD PLAYER screen.

## Types of CDs that can be used with this unit

This unit is compatible with 12-cm and 8-cm CD, CD-R, CD-RW and CD-RW High Speed discs. This unit does not support CD-RW Ultra Speed or CD-RW Ultra Speed+ discs. For the functions that can be used with discs and the types of compatible discs, see "Media Compatibility Table" on page 91.

### ■ Writing to an already written CD-RW

With this unit, you do not need to erase a CD-RW beforehand. You can use a previously written CD-RW by erasing it at the beginning of the desired operation.

When creating an Audio CD, the following message will appear if you load an already written CD-RW disc.

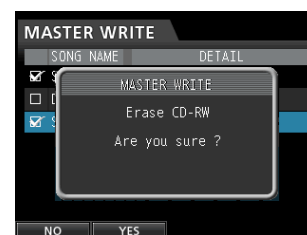

Confirmation message

Press the **F2 (Yes)** button to erase the songs recorded on the disc.

If you do not want to erase the CD-RW disc, press the **F1 (NO)** button. The disc tray will open slightly. Pull the tray out and replace the disc with another one.

### CAUTION

If you use Track At Once to write a master file to an unfinalized CD-RW in Audio CD format (a CD-RW created by selecting a single master file on the MASTER WRITE screen and setting FINALIZE to OFF), the file will be added without showing the CD-RW erasure warning, and it will not overwrite existing data on the disc.

## Loading and ejecting CDs

Place the disc on the disk tray on the front panel.

1. When Recorder mode is Multi Track mode, press the CD button to open the CD menu screen.

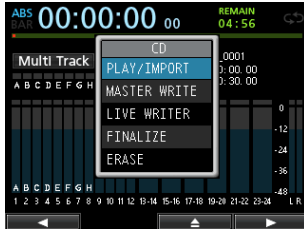

2. Press the F3 (▲) button or the disc tray eject button on the front panel to open the tray slightly. Pull the tray out until it opens completely as shown below.

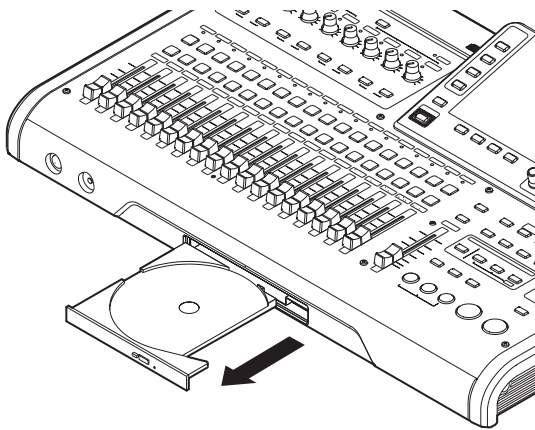

### CAUTION

- Pull the tray out completely. If you try to load a disc into the tray or remove a disc from it when it is not open completely, the disc could be scratched, making it unusable.
- Do not touch the writable side of a disc (the unlabeled side). Doing so could cause it to become dirty or scratched, making it unusable.

## Loading a CD

1. As shown in the illustration, hold the edge of the disc with the label side up and put it into the tray so that its central hole is on the round protrusion in the center of the tray.

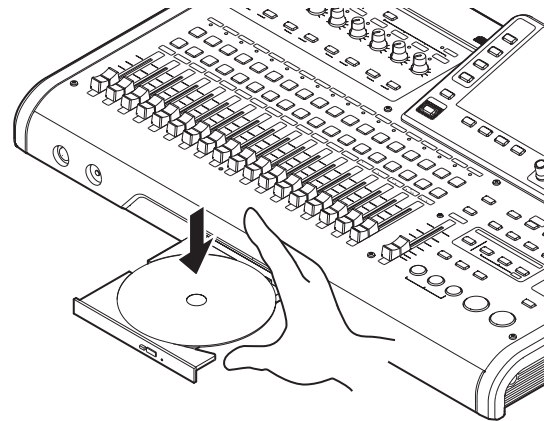

2. Press the disc gently near the center to set it on the tray. The disc should click into place and be level with the tray.
3. Push the tray to close it. The tray will click when shut.

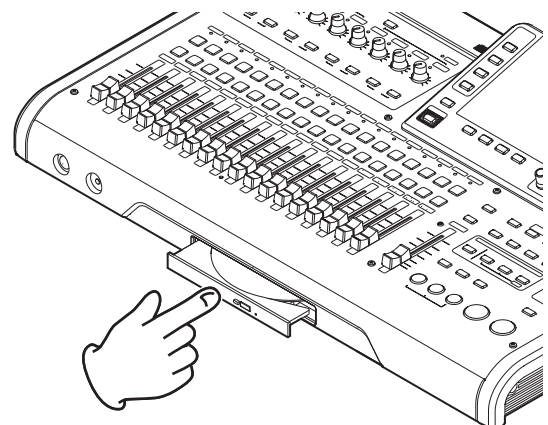

### ■ When a disc is not properly loaded

Pull the tray out completely once, reload the disc properly and push the tray closed again. (If you force the disc in, the unit or the disc could be damaged.)

# 14 - Using CDs

## Ejecting a CD

1. When Recorder mode is Multi Track mode, press the CD button to open the CD menu screen.

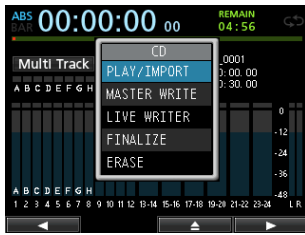

2. Press the F3 (▲) button or the disc tray eject button on the front panel to open the tray slightly, and then pull the tray out until it opens completely.

Hold the disc by its edges and lift it out.

### CAUTION

Do not lift the disc forcibly. Doing so could damage the unit or the disc.

## Forcing disc ejection

If the disc is not ejected even when you press the F3 (▲) button of the CD menu screen or press the disc tray eject button on the front panel due to a failure of the CD drive, etc., you can eject the disc by using the emergency eject button (emergency eject hole).

Before using the emergency eject function, turn the power off (standby), disconnect the AC adapter from the unit, and follow the procedure below.

1. Prepare an extended clip or another similar object.
2. Insert the extended clip into the emergency eject hole and press the inner button a couple of times.
3. When the disc tray opens slightly, use your hand to pull it out.

### CAUTION

- Use this function only in an emergency. Normally, remove the disk by the usual procedure. (See "Ejecting a CD" above.)
- Never perform the disc emergency ejection when power is ON.

## Playing back an Audio CD

1. Press the CD button to open the CD menu screen.
2. Load an Audio CD.
3. Use the JOG/DATA dial to select (blue highlight) **PLAY/IMPORT** and then press the F4 (▶) button.

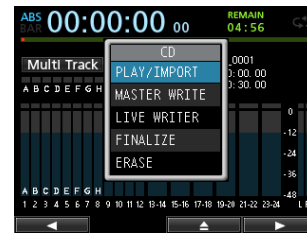

The CD PLAYER screen appears and the CD drive works as a CD player.



- 1 This shows the number of the track currently playing back.
  - 2 This shows the numbers and times of each track. You can use the JOG/DATA dial to move the selected track up and down. When the CD player is stopped, press the PLAY (▶) button to play back the selected track.
  - 3 This shows the elapsed time from the beginning of the track currently playing back.
  - 4 This is the level meter of the audio recorded on the CD. The playback signal sent from the CD to the MONITOR OUT jack or PHONES jack of this unit cannot be adjusted with the STEREO fader.
4. When the CD PLAYER screen is displayed, you can use the JOG/DATA dial and other buttons to control the CD player.

Button/dial	Description
JOG/DATA	Selects the track for playback.
STOP (■)	Stops the CD player.
PLAY (▶)	Plays back the selected track when pressed when CD player is stopped.
REW (◀◀) (TO ZERO)	Skips to previous track when near the beginning of a track. Returns to the beginning of the current track when in the middle of a track.
F FWD (▶▶) (TO LAST REC)	Skips to the next track.
STOP (■) + REW (◀◀) (TO ZERO)	Skips to the first track on the CD and stops.
F2 (✓)	Selects the track to be imported.
F3 (▲)	Stops the playback and opens the disc tray.
F4 (▶)	Executes the import.



## NOTE

During playback, selecting a track does not affect playback. Stop playback and start again to play the selected track.

## Creating an Audio CD

Using this unit, you can create Audio CDs that can be played back by ordinary CD players by writing the master files created for songs to CD-R and CD-RW discs. (See "Creating a master file" on page 69.)

Use the following three methods to create an Audio CD.

### ■ Disc At Once (DAO)

Use this method to write multiple master files at one time. Since this method automatically finalizes the disc, making it playable by an ordinary CD player, you will be able to use the completed disc with other CD players right away. (See "Finalizing a CD" on page 90.)

However, once DAO is completed, you will not be able to add any more tracks to the CD-R/CD-RW that was automatically finalized.

### ■ Track At Once (TAO)

Use this method to write a single master file at a time to a CD-R/CD-RW.

Use the Track At Once when you want to write files to the CD-R/CD-RW at different times.

With Track At Once, the CD-R/CD-RW is not automatically finalized.

Note, however, that a non-finalized CD-R/CD-RW can be played in this unit, but cannot be played in an ordinary CD player.

After you have written all the master files to a disc using Track At Once, finalize the disc. (See "Finalizing a CD" on page 90.)

You cannot add more tracks to a CD-R/CD-RW that has been finalized.

### ■ LIVE WRITER function

You can use marks to divide a master file into multiple parts, and write them as multiple tracks to a disc.

## Using Disc At Once

Use Disc At Once when you have selected multiple tracks.

Using Disc At Once, you can set the order of multiple tracks as you like. Moreover, you can set the time and add silent gaps between songs.

## NOTE

When using Disc At Once, you can also make multiple discs with the same contents. When doing so, use identical discs (same manufacturer, type and capacity).

1. When Recorder mode is Multi Track mode, press the CD button to open the CD menu screen.

2. Place a blank CD (unused CD-R/CD-RW disc or a completely erased CD-RW) on the disc tray.
3. Use the JOG/DATA dial to select (blue highlight) MASTER WRITE and then press the F4 (▶) button.

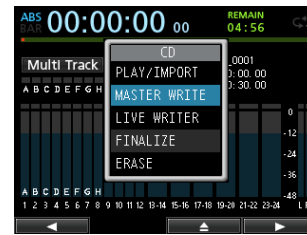

This opens the MASTER WRITE screen and shows a list of songs that have been recorded in master files. Master files that are not recorded at 44.1kHz or 16bit are not displayed.

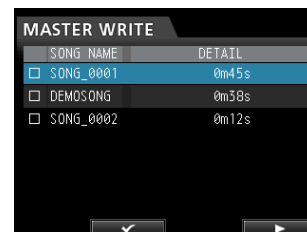

4. Use the JOG/DATA dial to select (blue highlight) songs which you want to write to CD-R/CD-RW, and press the F2 (✓) button to select the desired songs (selected songs check boxes are marked with ✓).

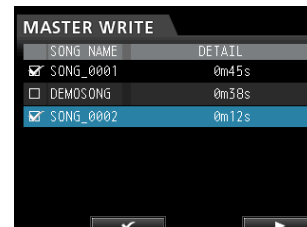

## NOTE

To remove the check mark ✓ from a check box, press the F2 (✓) button again while the song is selected (blue highlight).

5. Repeat step 4 above as necessary.
6. After you finish selecting songs, press the F4 (▶) button.

The WRITE SONG LIST screen appears. On this screen, you can change the order that the master files will be written to the CD-R/CD-RW and set the gaps between them.

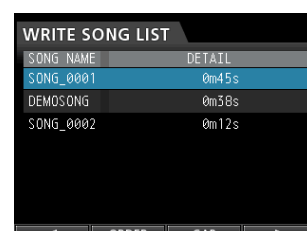

# 14 - Using CDs

7. To change the song order, press the **F2 (ORDER)** button to open the **WRITE SONG ORDER** screen (song order change screen).

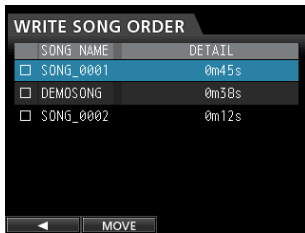

8. Use the **JOG/DATA** dial or the **CURSOR (▲/▼)** buttons to select (blue highlight) the song whose order you want to change, and then press the **F2 (MOVE)** button.

✓ appears before the song name.

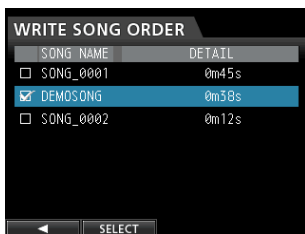

9. Use the **JOG/DATA** dial to shift the song position. Press the **F2 (SELECT)** button to confirm.

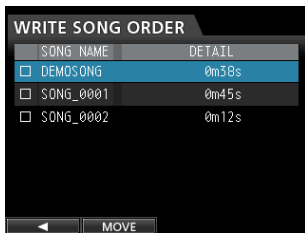

To change the order of multiple songs, repeat the steps 8 and 9 above.

10. When the song order is as you want, press the **F1 (◀)** button to return to the **WRITE SONG LIST** screen.
11. To change the gap between the songs, press the **F3 (GAP)** button. The **WRITE SONG GAP** screen appears.

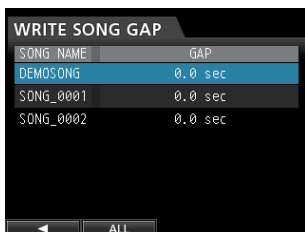

12. Use the **CURSOR (▲/▼)** buttons to select (blue highlight) the songs whose gap you want to change, and then use the **JOG/DATA** dial to set the gap.

The song gap can be set between 0.0 to 9.9 seconds, in 0.1 units.

## NOTE

To change the gap between multiple songs, repeat the step 12 above.

13. You can press the **F2 (ALL)** button to set all gaps at once.

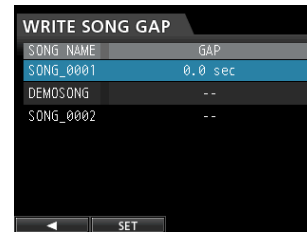

Use the **JOG/DATA** dial to set the gap between the songs.

Press the **F2 (SET)** to confirm the setting and return to the **WRITE SONG GAP** screen.

14. Once the change is completed, press the **F1 (◀)** button to return to the **WRITE SONG LIST** screen.
15. After finishing the song order and song gap settings, press the **F4 (▶)** button.
16. As a confirmation message appears, press the **F2 (YES)** button to confirm. The CD-R/CD-RW writing starts.

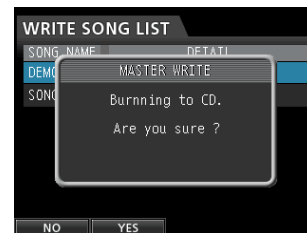

## NOTE

If you want to cancel the writing, press the **F1 (NO)** button to return to the **WRITE SONG LIST** screen.

17. When writing is completed, a message appears asking whether you want to write another CD-R/CD-RW with the same contents.

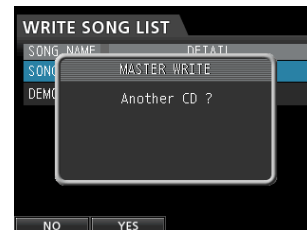

If you want to burn another CD-R/CD-RW with the same contents, press the **F2 (YES)** button. If you do not want to burn another disc, press the **F1 (NO)** button.

## Using Track At Once

When using Track At Once, after one track is written, a 2 second gap is added after it.

1. When Recorder mode is Multi Track mode, press the CD button to open the CD menu screen.
2. Place a blank CD (unused CD-R/CD-RW disc or a completely erased CD-RW) on the disc tray.

### NOTE

If you put a CD-R/CD-RW that has been used previously to write tracks using Track At Once and has not been finalized, you can add another track to it. In this case, the pop-up window for erasing a CD-RW disc does not appear.

3. Use the JOG/DATA dial to select (blue highlight) MASTER WRITE and then press the F4 (▶) button.

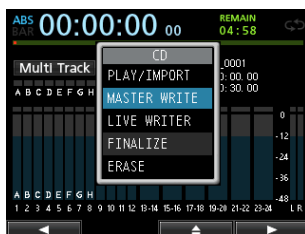

This opens the MASTER WRITE screen and shows a list of songs that have been recorded in master files. Master files that are not recorded at 44.1kHz or 16bit are not displayed.

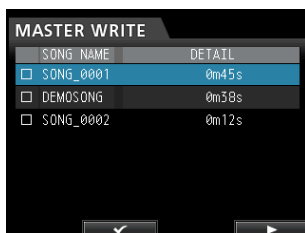

4. Use the JOG/DATA dial to select (blue highlight) only one song to write to the CD-R/CD-RW, and then press the F2 (✓) button.

A check mark ✓ appears in the check box next to the selected song.

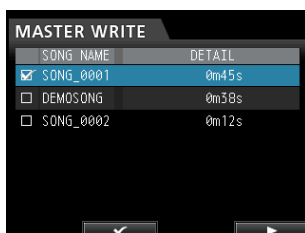

### NOTE

To remove the check mark ✓ from a check box, press the F2 (✓) button again while the song is selected (blue highlight).

5. Press the F4 (▶) button.

A pop-up window asking whether you want to perform the finalize process appears when the writing is completed.

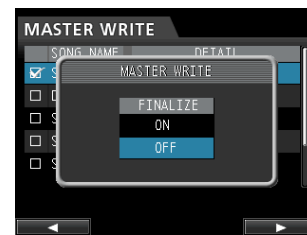

### TIP

Finalize the disc if you do not plan to add any more tracks to the CD-R/CD-RW. (See "Finalizing a CD" on page 90.)

6. To finalize, use the JOG/DATA dial to select ON, otherwise, select OFF, and then press the F4 (▶) button again. (Default: OFF)

The confirmation message shown below appears.

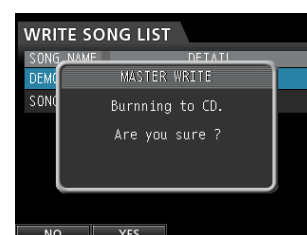

7. Press the F2 (YES) button to begin writing to the CD-R/CD-RW.

## Using LIVE WRITER

1. When Recorder mode is Multi Track mode, press the CD button to open the CD menu screen.
2. Place a blank CD (unused CD-R/CD-RW disc or a completely erased CD-RW) on the disc tray.
3. Use the JOG/DATA dial to select (blue highlight) LIVE WRITER and then press the F4 (▶) button.

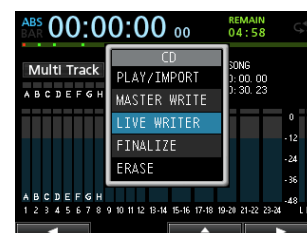

This opens the LIVE WRITER screen where you can divide a master file by setting position marks to it. Master files that are not recorded at 44.1kHz, 16bit, are not displayed.

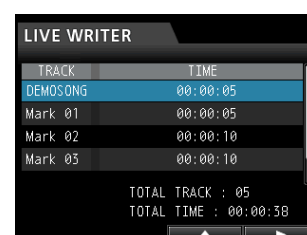

At this time, if there is no master file created or if no mark has been set, the messages appear.

# 14 - Using CDs

- 4. The column for TRACK 1 shows the song name, the columns for TRACK 2 and after show the mark name.

Press the **F4 (▶)** button and the following confirmation message will appear.

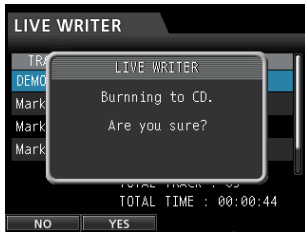

- 5. Press the **F2 (YES)** button to begin writing to the CD-R/CD-RW.

## Finalizing a CD

If you do not plan to write any more songs to a CD-R/CD-RW using Track At Once, finalize it so that it can be played on a regular CD player.

- 1. When Recorder mode is Multi Track mode, press the **CD** button to open the **CD** menu screen.
- 2. Load the CD-R/CD-RW which you want to finalize.
- 3. Use the **JOG/DATA** dial to select (blue highlight) **FINALIZE** and then press the **F4 (▶)** button.



The finalize confirmation message appears.

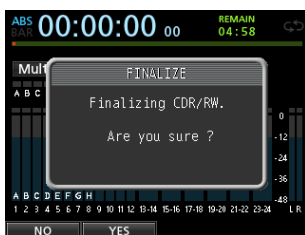

- 4. Press the **F2 (YES)** button to perform the finalize.

### NOTE

Note that an unfinalized CD-R/CD-RW cannot be played in an ordinary CD player.

You cannot add tracks to a disc that has been finalized.

## Importing songs from an Audio CD

You can import tracks (songs) from an Audio CD to the AudioDepot folder.

- 1. When Recorder mode is Multi Track mode, press the **CD** button to open the **CD** menu screen.
- 2. Load the Audio CD on the disc tray.
- 3. Use the **JOG/DATA** dial to select (blue highlight) **PLAY/IMPORT** and then press the **F4 (▶)** button.

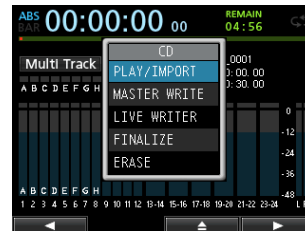

The **CD PLAYER/IMPORT** screen appears.

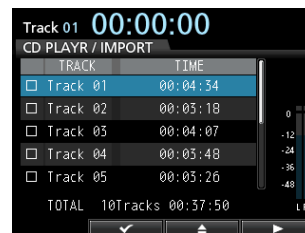

- 4. Use the **JOG/DATA** dial to select the tracks that you want to import, confirm with the **F2 (✓)** button, and then press the **F4 (▶)** button to start the import process.

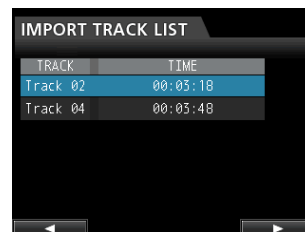

- 5. As a confirmation message appears, press the **F2 (YES)** button to confirm.



The import from the Audio CD is carried out and when it is completed, the display returns to the **CD** menu screen.

## Erasing a CD-RW

Follow the procedure below to erase the songs recorded on a CD-RW disc.

1. When Recorder mode is Multi Track mode, press the CD button to open the CD menu screen.
2. Load the CD-RW which you want to erase.
3. Use the JOG/DATA dial to select ERASE and then press the F4 (▶) button.

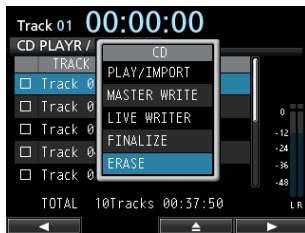

The confirmation message appears.

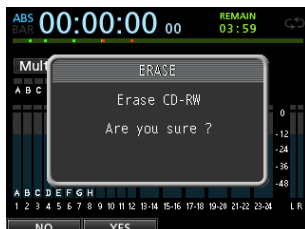

4. Press the F2 (YES) button to begin erasing the CD-RW.

After the disc is erased, the display returns to the CD menu screen.

### CAUTION

This operation erases the entire CD-RW. The erased data cannot be restored.

Confirm that you will not lose important data before erasing a disc.

### NOTE

CD-R discs cannot be erased.

## Media Compatibility Table

	Audio CD Playback Audio CD Import	Audio CD Writing
CDDA standard format Commercially available CD	A	—
CDDA standard format Made on this CD-R/CD-RW player	A	—
CDDA standard format Made on a CD player other than this CD-R/CD-RW player	B	—
CDDA standard format Made on this CD-R/CD-RW player Non-finalized	A	A
CDDA standard format Made on a CD player other than this CD-R/CD-RW player Non-finalized	N	N
Format other than CDDA standard Commercially available CD (Protected CD, DATA CD, CD extra, etc.)	B	—
CDDA standard format CD-R/CD-RW (DATA CD, CD extra, etc.)	B	—
CD-R/CD-RW ~ HIGH Speed	—	A
"Ultra Speed" CD-RW	N	N

A: Compatible, B: Operation not assured, N: Not compatible

# 15 – Troubleshooting

When working with this unit, if something is not going the way you want, or if you experience any difficulties, etc., first refer to this troubleshooting section. It contains the most common troubles, the probable causes, and the corrective measures. Also, see the "Messages" section on page 93 for the meaning of messages that may pop up on the display. Consult this table when a message appears when an operation cannot be completed by the unit.

## The SD card is not recognized.

- Confirm that the SD card is completely inserted.

## Why can't I hear any sound when I play back?

- Are the track faders of the tracks set to a proper level?
- Is the **STEREO** fader set to a proper level?
- Have you connected the **PHONES** or **MONITOR OUT** jack to your monitoring system properly?  
Is your monitoring system set up correctly?
- Is the **MONITOR LEVEL** knob set to a proper level? (**PHONES** jack only)

## The sound I am trying to record sounds distorted.

- Aren't the **INPUT A** to **H TRIM** knobs on the top panel of the unit set too high?  
Isn't the input source too loud?
- Isn't the monitoring system distorted because the monitor level is too high?

## Why can't I record?

- You must have at least one track in recording standby (**REC** indicator flashing) before you start recording by pressing the **RECORD** (●).
- Are input sources assigned to tracks? (See "Assigning inputs" on page 44.)

## Noise occurs if I connect a passive guitar or bass directly.

- Connecting another device to the unit's stereo output (**STEREO OUT**) jacks might reduce the noise.
- This might be caused by interference noise from another device. If there is a power amplifier or other device that uses a large transformer, a fluorescent light or something similar nearby, you might be able to reduce the noise by changing the distance and orientation of this unit in relation to such equipment.
- You might also be able to reduce the noise if you use this unit's **GROUND** connector to ground the unit.

## The disc tray does not open.

- The disc tray will not open unless the CD mode is selected (CD screen or its sub-menu is displayed). Return Recorder mode to **Multi Track** mode, press the **CD** button to open the CD menu screen, and then press the **F3** (▲) button or the disc eject button on the front panel.

## An Audio CD that I made cannot be played on an Audio CD player.

- Did you finalize the Audio CD?  
An Audio CD that has not been finalized cannot be played on an ordinary Audio CD player. Finalize the CD and try again (you cannot record on the CD any more after finalizing it).
- Aren't you trying to play a CD-RW disc on an Audio CD player that does not support CD-RW media?  
Use a compatible Audio CD player or create a new Audio CD using a CD-R disc (depending on the Audio CD player, even a CD-R disc might not be played back).

## I cannot or fail to create an Audio CD.

- Are you using a blank CD (CD-R/CD-RW) that is supported by this unit?  
This unit does not support CD-RW Ultra Speed or CD-RW Ultra Speed+ discs.
- Depending on the manufacturer and type of CD-R/CD-RW, writing might fail, writing might succeed but result in an unreadable disc, or writing might take a long time. In any of these cases, try using a CD-R/CD-RW from a different manufacturer or of a different brand.



## General messages

The following list shows the messages that may pop up during the use of the unit.

These messages alert you to conditions that may arise while you are using the unit. Consult the table below if you see something you do not understand or if you want to know how to solve a problem.

Message	Description and remedy
Can not Import	This pop-up appears when the Sample Rate or Sample Bit of the selected file in the AUDIO DEPOT-IMPORT menu differs from the current song.
Cannot Clear Current	The current track cannot be deleted. A virtual track assigned to a physical track cannot be deleted.
Card Error	The card could not be handled properly. Replace the card.
Card Full	The card has no remaining capacity. Erase unnecessary files or move them to your computer to make open space.
Empty Export Track	You tried to export a track that does not contain any recording data. This pop-up appears if you try to export a song track that does not contain any recording. (See "Exporting tracks" on page 83.) Export a song track that has been recorded.
Export File Too Big	The track to be exported exceeds the SD card available capacity. You have tried to export a track to the AudioDepot folder, but the size is too large for the remaining space on the SD card. Delete unnecessary songs or files from the AudioDepot folder to create more space on the SD card, then try to export the track again.
File Not Found	File to be imported could not be found. You tried to import a WAV file from the AudioDepot folder, but there is no WAV files in it. (See "Importing tracks" on page 82.) Connect the unit to a computer and transfer the files that you want to import from the computer to the AudioDepot folder of the unit.
Format Error Format CARD	The formatting of the card is abnormal or corrupted. This message also appears if you formatted the card for FAT format using a computer connected via USB and if an unformatted card is inserted in the unit. Always use the DP-24 to format cards to be used with it. Replace the card or format the card using the FORMAT menu. Execution of FAT formatting erases all data currently on the card.
I/O Too Short	Interval between IN and OUT points is too short. You tried to enter repeat mode, but the time between the IN and OUT points is too short.
Import Failed Export Failed	Import or export failed.
Import File Too Large	Size of file to be imported is too big. You tried to import a WAV file from the AudioDepot folder that is too large for the remaining space on the SD card. Free up some space in the AudioDepot folder by deleting unnecessary songs, and try again.
In Bounce Mode	Bounce mode is active. You tried to perform an action that cannot be done while in Bounce mode.
In Master Mode	Mastering mode is active. You tried to perform an action that cannot be done while in Mastering mode.
In Punch Mode	Auto Punch mode is active. You tried to perform an action that cannot be done while in Auto Punch mode.
In Repeat Mode	Repeat Playback mode is active. You tried to perform an action that cannot be done while in Repeat Playback mode.
Invalid Card	The format of the inserted SD card cannot be used in this unit. Insert another SD card after turning off the unit, or format the card using FORMAT on the MENU screen.
Invalid Card Change Card	Something might be wrong with the card. Replace the card.
Mark Full	It is not possible to register more location marks. You tried to store more than 99 location marks in a song. (See "Location marks" on page 54.) Delete some location marks and try again.

## 16 – Messages

Master File Not Found	Master file could not be found. This message appears if you try to enter Mastering mode, but you have not made any mixdown recording yet. First perform a mixdown recording.
Master Track Too Large	The master file is too large. You tried to create a master file that is larger than the remaining available space on the SD card. Format the SD card (see "Quick formatting an SD card" on page 78 and "Full formatting an SD card" on page 79), or connect the unit to a computer and delete unnecessary files to create available space in the card.
MBR Error Init CARD	The formatting of the card is abnormal or corrupted. Replace the card or format the card using the FORMAT menu. Execution of formatting erases all data currently on the card.
No Card	No SD card is in the unit. Load a recordable SD card.
No Armed Track	There is no track in recording standby. You tried to enter auto punch mode or press the <b>RECORD</b> button when no tracks were in record standby. (See "Auto punch in/out" on page 57.) Put a track into record standby before pressing the <b>RECORD</b> button or entering the auto punch mode.
No Undo History	There is no undo history. There are no actions to be undone. (See "Undoing an operation" on page 50.)
Not Stopped	The recorder is not stopped. When the recorder is not stopped, this message appears when you press a button that works only when the recorder is stopped, such as the <b>UNDO/REDO</b> button, etc.
Now Recording	A recording is being performed. This message appears when you try to operate a menu while a recording is being performed. There are also other operations that are not allowed during a recording.
OUT point must be set after the IN point.	You cannot set the OUT point before the IN point. Set the OUT point after the IN point.
Protected Card	The inserted SD card is write-protected. To record or edit, turn off the unit and unprotect the SD card.
Recorded Track Not Found	During execution of the export menu, the current song has no tracks recorded in it. No tracks are recorded in the current song, or virtual tracks are not assigned to physical tracks. Select a recorded song, assign the track you want to export to a physical track, and then export it. (See "Virtual tracks" on page 59.)
Revert to discard changes.	Editing and changes made from when loaded will be cleared, and reset to the same status as when loaded. Proceed only when you are sure you wish to clear these changes.
Same Track	The same track has been specified. This message appears in the clone track setting, when the same track is specified.
Song Protected	The song is protected. The song is protected and you are trying to change it (record, edit, etc.). (See "Protecting songs" on page 41.) Unprotect the song.
Stereo Track Full	The stereo track is already recorded. This message appears if you try to import a stereo file when a stereo track is already recorded in the song.
Track Full	The track is already recorded. This message appears if you try to import a file when all tracks already have recordings. (See "Importing tracks" on page 82.)
Trk Edit Fail	Track edit failed. Save the song and turn the unit off and then on, and perform track edit again.
Trk Too Short	The track is too short. You are trying to start a record in mixdown mode, but the time between the IN and OUT points is too short. The IN and OUT points must be at least 4 seconds apart. (See "Setting IN/OUT points" on page 56.)
Turn off the Guitar Effect or use two or less Dynamic Effects.	While using a guitar effect, the use of dynamic effects is limited to only 1–2 channels. To use dynamic effects on 3 or more channels, turn the guitar effect OFF.

Work Memory Full	The work memory is full. Even if the SD card has enough remaining space, this error may occur when you perform many editing operations. You may be able to continue the work if execute the <b>DELETE UNUSED</b> item of the <b>SONG</b> menu to increase the available space in the work memory. (See "Undoing an operation" on page 50.)
Audio Rst Fail	If any of these errors occur, turn the unit power off and restart it. If these error messages continue to appear, please contact a TEAC Service Center.
Device Error	
File Error	
No CD Drive	
Not Continued	
Remote Cmd	
Remote Rx	
Sys Rom Err	
System Err 50	
System Error 1	
System Error 2	
System Error 3	
System Error 4	
System Error 5	
System Error 6	
System Error 7	
System Error 8	
System Error 9	
Writing Failed	

## CD mode messages

The following pop-up messages appear when the unit is in CD mode (when the **CD** menu screen or one of its submenus is open).

Refer to this chart when you want to understand the meaning of these messages and how you should respond to them.

Message	Description and remedy
Blank CD Insert CD-RW	A blank CD has been inserted. Insert a CD-RW that is not blank. An erased CD-RW or unwritten CD-RW has been set with the <b>ERASE</b> item of the <b>CD</b> menu screen. There is no need to erase the inserted CD-RW.
Blank CD Insert Opened CD	A blank CD has been inserted. Insert a non-finalized CD-R/CD-RW. An erased CD-R/CD-RW or unwritten CD-R/CD-RW has been set with the <b>FINALIZE</b> item of the <b>CD</b> menu screen. Insert the CD-R/CD-RW that you want to finalize.
Finalized CD Insert CD-RW	A finalized CD-RW has been inserted. Insert a non-finalized CD-RW. A finalized CD-R/CD-RW has been inserted with the <b>ERASE</b> item of the <b>CD</b> menu screen. Only CD-RW discs can be erased.
Finalized CD Insert Opened CD	A finalized CD-R/CD-RW has been inserted. Insert a non-finalized CD-R/CD-RW. A finalized CD-R/CD-RW has been inserted with the <b>FINALIZE</b> item of the <b>CD</b> menu screen. This CD-R/CD-RW does not need to be finalized.
Import File Too Big	Size of file to be imported is too big. The size of the file to import equals or exceeds the free space on the SD card when executing an import with the <b>CD-DA IMPORT</b> item of the <b>CD</b> menu screen. Create more free space on the SD card by erasing the undo operation history, for example, to ensure sufficient free space for reading the import file.
Invalid CD Insert Blank CD	An invalid CD-R/CD-RW has been inserted. Insert a blank CD. When you try to write to a CD-R/CD-RW using the <b>MASTER WRITE</b> or the <b>CD BACKUP</b> item of the <b>CD</b> menu screen, but inserted a CD-R/CD-RW that is not a blank CD. (When writing with Track At Once, this message appears if a finalized CD-R/CD-RW is set.) Insert a blank CD.

## 16 – Messages

Invalid CD Insert CD-RW	An invalid CD-R/CD-RW has been inserted. Insert a CD-RW. A CD-R has been set with the ERASE item of the CD menu screen. Insert a CD-RW to be erased.
Invalid CD Insert Opened CD	An invalid CD-R/CD-RW has been inserted. Insert a non-finalized CD-R/CD-RW. A CD-R/CD-RW that cannot be finalized has been inserted with the FINALIZE item of the CD menu screen. Insert the CD-R/CD-RW that you want to finalize.
No disc Insert Blank CD	There is no CD-R/CD-RW inserted. Insert a blank CD. There is no CD-R/CD-RW loaded in the disc tray, but you tried to write to a CD-R/CD-RW with the MASTER WRITE item of the CD menu screen. Insert a blank CD. Insert a blank CD and close the disc tray.
No disc Insert Opened CD	There is no CD-R/CD-RW inserted. Insert a non-finalized CD-R/CD-RW. There is no CD-R/CD-RW in the CD tray, but you tried to use the FINALIZE item of the CD menu screen.
No Room On CD	You tried to write data that exceeds the CD-R/CD-RW capacity. When you select a master file to be written to a CD-R/CD-RW with the MASTER WRITE item of the CD menu screen, the total volume of the specified master size exceeds the loaded CD-R/CD-RW capacity. Press the <b>HOME</b> button to exit CD menu screen, and specify the track to be written again.
Not Audio CD Insert Audio CD	You loaded a CD that is not an Audio CD. Insert an Audio CD. This message appears if the loaded CD is not an Audio CD, when you try to use the audio import function with the CD-DA IMPORT item of the CD menu screen. Insert an Audio CD.
Not Blank Insert Blank CD	A non-finalized CD-R/CD-RW has been inserted. Insert a blank CD. This message appear when a non-finalized CD-R/CD-RW (written with Track At Once) is loaded, but you try to create an Audio CD with Disc At Once. Either insert a blank CD or write with Track At Once.

### CD-related error messages

If you experience a problem while reading or writing a CD, you may see one of the following error messages.

When one of the messages is displayed, press the **HOME** button to exit the CD menu screen, check the state of the media, etc., and retry the operation.

Message	Description and remedy
CD Read Error	An error occurred in the FINALIZE, CD-DA IMPORT, or ERASE execution process of the CD menu screen.
CD Write Error	An error occurred in the FINALIZE or ERASE execution process of the CD menu screen.
Erase Error	An error occurred in the ERASE execution process of the CD menu screen.
Finalize Error	An error occurred in the FINALIZE execution process of the CD menu screen.
Import Error	An error occurred in the CD-DA IMPORT execution process of the CD menu screen.
Media Error	An error occurred in the CD PLAYER execution process of the CD menu screen.
Writing Failed	An error occurred in the CD-R/CD-RW writing process with the MASTER WRITE item of the CD menu screen.

---

## Ratings

---

### Recording media

- SD card (512 MB to 2 GB)
- SDHC card (4 GB to 32 GB)

### File system

- SD card (512 MB to 2 GB) : FAT16
  - SDHC card (4 GB to 32 GB) : FAT32
- 

## Input/output ratings

---

### Analog audio input/output ratings

#### INPUT A to H jack

- **XLR type (Balanced)**

- Connector: XLR-3-31 (1 : GND, 2 : HOT, 3 : COLD)
- Input impedance: 2.4 k $\Omega$
- Rated input level: -14 dBu
- Maximum input level: +2 dBu

- **Standard jack type (Balanced)**

- Connector: 6.3 mm (1/4") TRS standard jack
- Input impedance:
  - Above 22 k $\Omega$
  - 1 M $\Omega$  (INPUT H only, when **LINE-GUITAR** switch is set to **GUITAR**)
- Rated input level: +4 dBu
- Maximum input level: +20 dBu

#### STEREO OUT jack

- Connector: RCA pin jack
- Rated output level: -10 dBV
- Maximum output level: +6 dBV
- Output impedance: 200  $\Omega$

#### EFFECT SENDS jack

- Connector: 6.3 mm (1/4") TS standard jack
- Rated output level: -10 dBV
- Maximum output level: +6 dBV
- Output impedance: 200  $\Omega$

#### MONITOR OUT jack

- Connector: 6.3 mm (1/4") TRS standard jack
- Rated output level: -2 dBu
- Maximum output level: +14 dBu
- Output impedance: 200  $\Omega$

#### PHONES jack

- Connector: 6.3 mm stereo jack
- Maximum output level: 70 mW+70 mW or more (THD+N 0.1% or less, 32  $\Omega$  load)

---

## Control input/output ratings

### MIDI input (MIDI IN)

- Connector: 5-pin DIN
- Format: Standard MIDI format

### MIDI output (MIDI OUT)

- Connector: 5-pin DIN
- Format: Standard MIDI format

### USB port

- Connector: USB 4-pin mini-B type
- Format: Mass Storage Class USB 2.0 HIGH SPEED

### REMOTE jack

- Connector: 2.5 mm TRS jack
- 

## Audio performance

---

### Frequency response

- INPUT (MIC/LINE) → STEREO OUT/EFFECT SENDS/MONITOR OUT: 20 Hz to 20 kHz, +1 dB/-1 dB

### Distortion

- INPUT (MIC/LINE) → STEREO OUT/EFFECT SENDS/MONITOR OUT: 0.01% or less

### S/N ratio

- INPUT (MIC/LINE) → STEREO OUT/EFFECT SENDS/MONITOR OUT: 90 dB or more
- 

## Operating requirements

---

See the TASCAM website (<http://www.tascam.com/>) for updated information about OS compatibility.

### Windows

- Pentium 300 MHz or faster
- 128 MB or more memory
- USB port (USB 2.0 recommended)

### Macintosh

- Power PC, iMac, G3, G4 266 MHz or faster
- 64 MB or more memory
- USB port (USB 2.0 recommended)

### Recommended USB host controller

- Intel chipset

### Supported OS

- Windows: Windows XP, Windows Vista, Windows 7
- Macintosh: Mac OS X 10.2 or later

# 17 – Specifications

## General

### Power supply

AC adapter (TASCAM PS-1225L)

### Power consumption

12 W (Phantom power ON)

### Dimensions

514 x 104 x 340 mm (Width x Height x Depth, excluding projections)

### Weight

6.2 kg/13.67 lb

### Operating temperature range

5 to 35°C/41 to 95°F

## Dimensional drawings

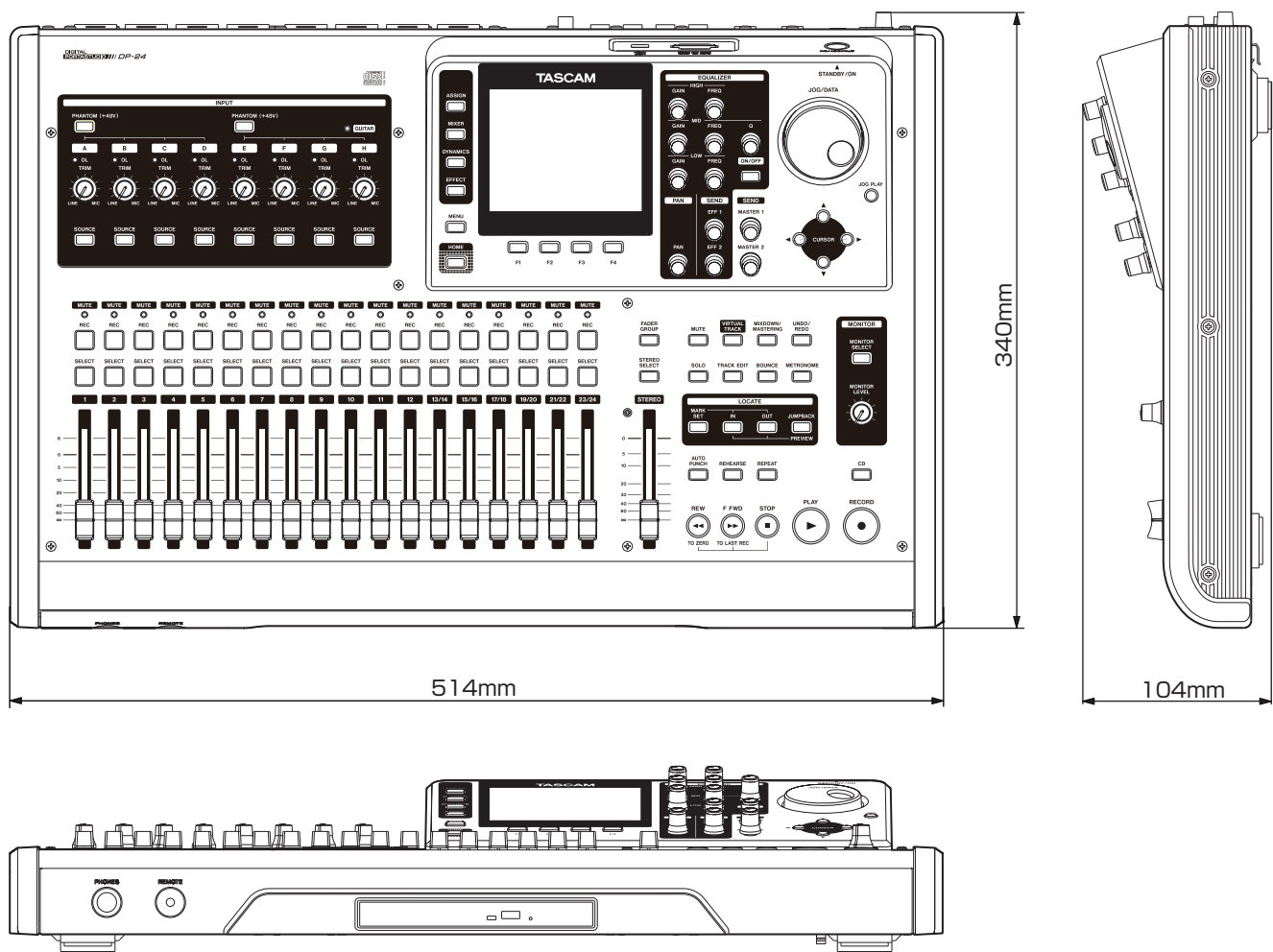

\* Illustrations in this manual may differ from the actual product.

\* In order to improve the product, specifications and appearance could be changed without prior notice.



## Block diagram

DP-24 Mixer Block Diagram

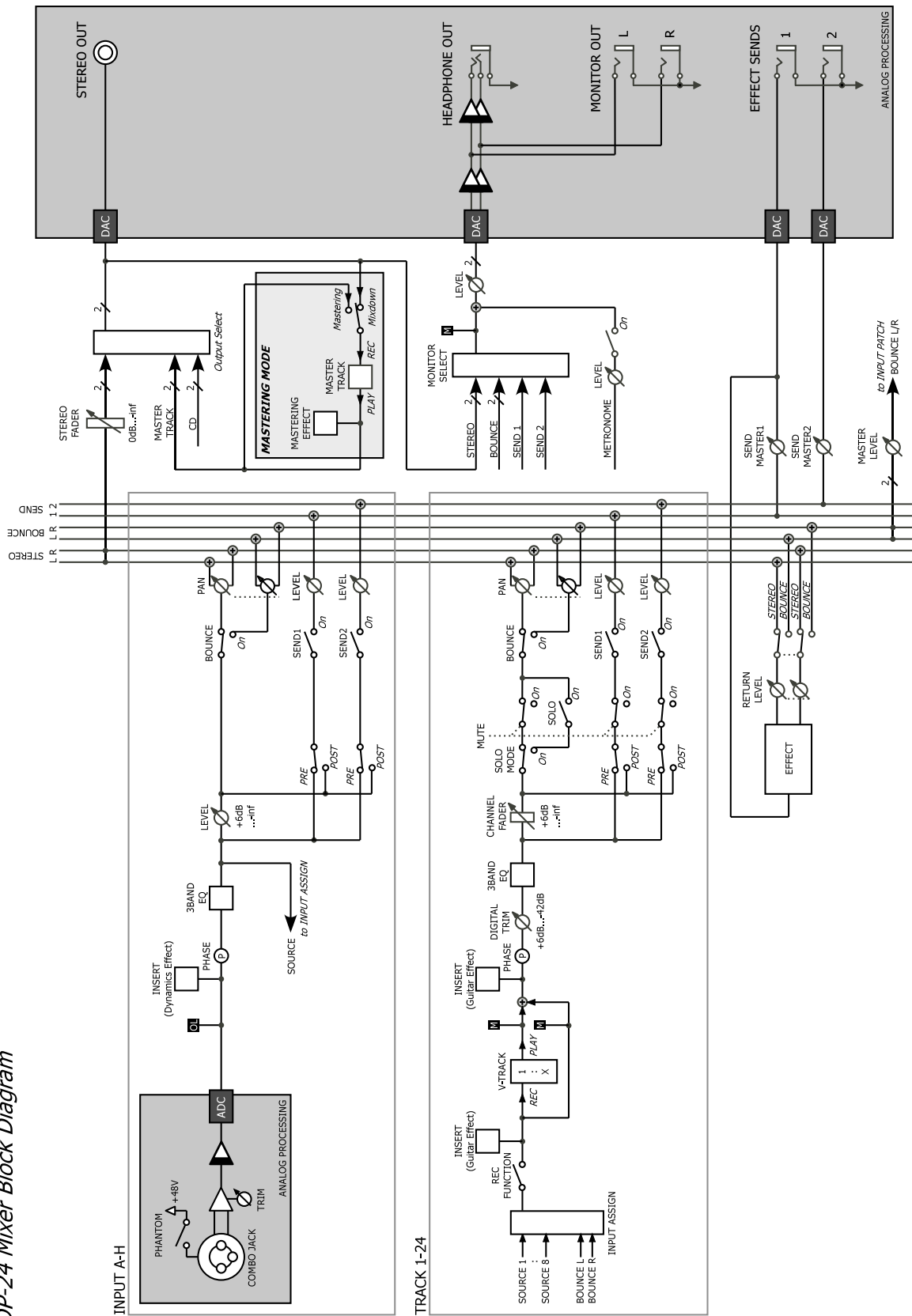

# 17 – Specifications

## Level diagram

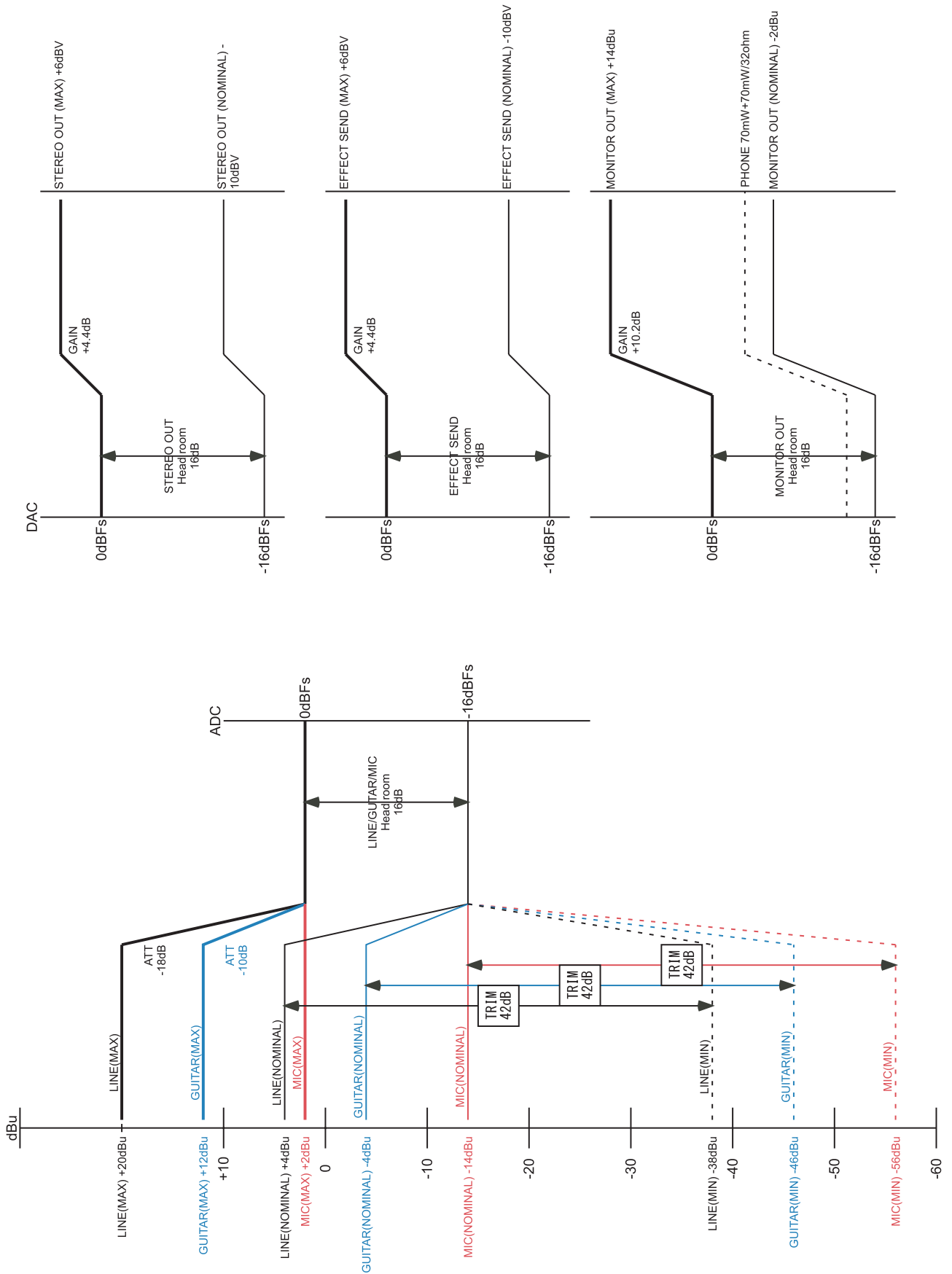

## MIDI Control Change message

When this unit receives MIDI Control Change messages from an external device (such as a sequencer), it can control the mixer parameters and effect parameters.

### Mixer control change parameters

Select a channel group of 8 track/input channels beforehand.

The Bank Select message is used with the MIDI channel 14 to select a channel group.

- Bank 0: track channels 1 to 8
- Bank 1: track channels 9 to 16
- Bank 2: track channels 17 to 24
- Bank 3: inputs A to H

The following table shows the variable range of mixer parameter and mapping to the MIDI Control Change.

MIDI Channel		1 - 8	16
		Track/Input Channel	Stereo Master
Control Change Number	Parameter	Values	
7	Internal Level	0 - 127 (0=-∞dB, 105=0dB, 127=+6dB)	0 - 127 (-∞ - 0dB)
10	Pan	1 - 64 - 127=L63 - C (center) - R63	—
11	DigitalTrim	0 - 48 (-42 - +6dB)	
16	Low Freq	0 - 31= 32, 40, 50, 60, 70, 80, 90, 100, 125, 150, 175, 200, 225, 250, 300, 350, 400, 450, 500, 600, 700, 800, 850, 900, 950, 1.0k, 1.1k, 1.2k, 1.3k, 1.4k, 1.5k, 1.6k (Hz)	
17	Low Gain	0 - 24=-12 - +12 (dB)	
18	Mid Freq	0 - 63= 32, 40, 50, 60, 70, 80, 90, 100, 125, 150, 175, 200, 225, 250, 300, 350, 400, 450, 500, 600, 700, 800, 850, 900, 950, 1.0k, 1.1k, 1.2k, 1.3k, 1.4k, 1.5k, 1.6k, 1.7k, 1.8k, 1.9k, 2.0k, 2.2k, 2.4k, 2.6k, 2.8k, 3.0k, 3.2k, 3.4k, 3.6k, 3.8k, 4.0k, 4.5k, 5.0k, 5.5k, 6.0k, 6.5k, 7.0k, 7.5k, 8.0k, 9.0k, 10k, 11k, 12k, 13k, 14k, 15k, 16k, 17k, 18k (Hz)	
19	Mid Gain	0 - 24=-12 - +12 (dB)	
20	Mid Q	0 - 6=0.25, 0.5, 1, 2, 4, 8, 16	
21	High Freq	32 - 63= 1.7k, 1.8k, 1.9k, 2.0k, 2.2k, 2.4k, 2.6k, 2.8k, 3.0k, 3.2k, 3.4k, 3.6k, 3.8k, 4.0k, 4.5k, 5.0k, 5.5k, 6.0k, 6.5k, 7.0k, 7.5k, 8.0k, 9.0k, 10k, 11k, 12k, 13k, 14k, 15k, 16k, 17k, 18k (Hz)	
22	High Gain	0 - 24=-12 - +12 (dB)	
23	EFFECT1 Level	0 - 127 (0=-∞dB, 127=0dB)	EFFECT1 Level
24	EFFECT2 Level	0 - 127 (0=-∞dB, 127=0dB)	EFFECT2 Level
80	EQ SW	0, 1=OFF, ON	
81	EFFECT1 Position	0, 1, 2=OFF, PRE, POST	
82	EFFECT2 Position	0, 1, 2=OFF, PRE, POST	

## MIDI Program Change message

When this unit receives MIDI Program Change messages, it can call settings from the effect libraries.

The Bank Select message of MIDI Control Change is used to select presets and users of the effect libraries.

Different MIDI Channels are applied for each item.

MIDI Channel	Parameter Function	Value
1 - 8*	Recalling the dynamic effect type	Bank 0 (Type): 0 - 3
10	Calling from the send effect library	Bank 0 (Preset): 0 - 6 Bank 1 (User): 0 - 9
11	Calling from the guitar effect library	Bank 0 (Preset): 0 - 9 Bank 1 (User): 0 - 9

\* The Bank Select message of MIDI Control Change is used with the MIDI channel 14 to select a channel group for the dynamic effect.

- Bank 0: track channels 1 to 8
- Bank 1: track channels 9 to 16
- Bank 2: track channels 17 to 24
- Bank 3: inputs A to H

The following tables show the preset libraries of each effect.

### Dynamic effects

Program Change	Display	Effect type
0	COMP	CMP
1	NOISE SUPPRESSOR	NSP
2	DE-ESSER	DSR
3	EXCITER	EXC

- CMP: Compressor
- DSR: De-Esser
- EXC: Exciter
- NSP: Noise Suppressor

### Preset libraries of the send effects

Program Change	Display	Effect type
0	HALL	REV
1	ROOM	REV
2	LIVE	REV
3	STUDIO	REV
4	PLATE	REV
5	CHORUS	CHO
6	STEREO DLY	DLY

- REV: Reverb
- DLY: Delay
- CHO: Chorus

### Preset libraries of the guitar effects

Program Change	Display	Effect type
0	PRESET 01	AMP, CMP, DLY
1	PRESET 02	AMP, CHO
2	PRESET 03	AMP
3	PRESET 04	AMP, CMP, DLY
4	PRESET 05	AMP, FLG
5	PRESET 06	AMP, CMP
6	PRESET 07	AMP, CMP, CHO
7	PRESET 08	AMP, CMP, PHA
8	PRESET 09	AMP
9	PRESET 10	AMP, CMP, WAH

- AMP: Amplifier
- CMP: Compressor
- FLG: Flanger
- PHA: Phaser
- CHO: Chorus
- WAH: Wah
- DLY: Delay

## MIDI Implementation Chart

Function		Transmitted	Recognized	Remarks
Basic Channel	Default	1 - 16	1 - 16	
	Changed	×	1 - 16	
Mode	Default	×	Mode 3	
	Messages	×	×	
	Altered	*****		
Note Number	True Voice	0 - 127	0 - 127	
		*****	0 - 127	
Velocity	Note On	×	×	
	Note Off	×	×	
Pitch Bend		×	×	
Control Change	0, 32	○*1	○*2	EFF Bank, CH Bank
	7, 10, 11	○	○	Mix Level, Pan, DigitalTrim
	16-22	○	○	Mix Eq
	23-28	○	○	Mix Send
	80, 81, 82	○	○	EQ SW, EFF1 Posi, EFF2 Posi
	6, 38	×	×	
	96, 97	×	×	
	98, 99	×	×	
Program Change		×	○	
	True #	*****	0 - 127	
System Exclusive		○	○	*5
System Common	Quarter Frame	○*3		
	Song Position	○*4	×	
	Song Select	×	×	
	Tune	×	×	
System Real Time	Clock	○	×	
	Commands	*4	×	
Others	Local On/Off	×	×	
	All Notes Off	×	×	
	Active Sense	×	×	
	Reset	×	×	
Notes	*1 When REMOTE is set to MASTER *2 When REMOTE is set to SAVE *3 When GENERATOR is set to MTC *4 When GENERATOR is set to CLOCK *5 When MMC is set to MASTER or SLAVE, RP version 1.00 (T, R): MIDI full time code message is T when GENERATOR is set to MTC.			

Mode 1: OMNI ON, POLY  
 Mode 2: OMNI ON, MONO  
 Mode 3: OMNI OFF, POLY  
 Mode 4: OMNI OFF, MONO

○: YES / ×: NO

# 18 – Appendix

## Bit-map array of MMC commands

Byte	Bit7	Bit6 (40H)	Bit5 (20H)	Bit4 (10H)	Bit3 (08H)	Bit2 (04H)	Bit1 (02H)	Bit0 (01H)
c0	- 0	(06) RECORD STROBE	(05) REWIND	(04) FAST FORWARD	(03) DEFERRED PLAY	(02) PLAY	(01) STOP	(00) reserved
c1	- 0	(0D) MMC RESET	(0C) COMMAND ERROR-RESET	(0B) CHASE	(0A) EJECT	(09) PAUSE	(08) RECORD PAUSE	(07) RECORD EXIT
c2	- 0	(14)	(13)	(12)	(11)	(10)	(0F)	(0E)
c3	- 0	(1B)	(1A)	(19)	(18)	(17)	(16)	(15)
c4	- 0	- 0	- 0	- 0	(1F)	(1E)	(1D)	(1C)
c5	- 0	(26)	(25)	(24)	(23)	(22)	(21)	(20)
c6	- 0	(2D)	(2C)	(2B)	(2A)	(29)	(28)	(27)
c7	- 0	(34)	(33)	(32)	(31)	(30)	(2F)	(2E)
c8	- 0	(3B)	(3A)	(39)	(38)	(37)	(36)	(35)
c9	- 0	- 0	- 0	- 0	(3F)	(3E)	(3D)	(3C)
c10	- 0	(46) SEARCH	(45) VARIABLE PLAY	(44) LOCATE	(43) UPDATE	(42) READ	(41) MASKED WRITE	(40) WRITE
c11	- 0	(4D) ADD	(4C) MOVE	(4B) MTC COMMAND	(4A) GENERATOR COMMAND	(49) ASSIGN SYS, MAS	(48) STEP	(47) SHUTTLE
c12	- 0	(54) DEFERRED VARI, PLAY	(53) COMMAND SEGMENT	(52) GROUP	(51) EVENT	(50) PROCEDURE	(4F) DROP-FR ADJUST	(4E) SUBTRACT
c13	- 0	(5B)	(5A)	(59)	(58)	(57)	(56)	(55) REC-STROBE VARIABLE
c14	- 0	- 0	- 0	- 0	(5F)	(5E)	(5D)	(5C)
c15	- 0	(66)	(65)	(64)	(63)	(62)	(61)	(60)
c16	- 0	(6D)	(6C)	(6B)	(6A)	(69)	(68)	(67)
c17	- 0	(74)	(73)	(72)	(71)	(70)	(6F)	(6E)
c18	- 0	(7B)	(7A)	(79)	(78)	(77)	(76)	(75)
c19	- 0	- 0	- 0	- 0	(7F) RESUME	(7E)	(7D)	(7C) WAIT









# TASCAM

# DP-24

## TEAC CORPORATION

Phone: +81-42-356-9143

1-47 Ochiai, Tama-shi, Tokyo 206-8530, Japan

<http://tascam.jp/>

---

## TEAC AMERICA, INC.

Phone: +1-323-726-0303

7733 Telegraph Road, Montebello, California 90640 USA

<http://tascam.com/>

---

## TEAC CANADA LTD.

Phone: +1905-890-8008 Facsimile: +1905-890-9888

5939 Wallace Street, Mississauga, Ontario L4Z 1Z8, Canada

<http://tascam.com/>

---

## TEAC MEXICO, S.A. de C.V.

Phone: +52-55-5010-6000

Río Churubusco 364, Colonia Del Carmen, Delegación Coyoacán, CP 04100, México DF, México

<http://www.teacmexico.net/>

---

## TEAC UK LIMITED

Phone: +44-8451-302511

Suites 19 & 20, Building 6, Croxley Green Business Park, Hatters Lane, Watford, Hertfordshire, WD18 8TE, UK

<http://www.tascam.co.uk>

---

## TEAC EUROPE GmbH

Phone: +49-611-71580

Bahnstrasse 12, 65205 Wiesbaden-Erbenheim, Germany

<http://www.tascam.de/>